

# GETTYSBURG DESIGN GUIDE

A Guide for  
Maintaining and Rehabilitating Buildings  
in the  
Gettysburg Historic District

Prepared for  
The Gettysburg Historic Architectural Review Board

by  
Margaret M.M. Pickart  
Richard C. Sutter & Associates  
Comprehensive Planners, Land Planners, Historic Preservation Planners  
Hollidaysburg, Pennsylvania

# ACKNOWLEDGMENTS

## Gettysburg Historic Architectural Review Board Members

Gary W. Shaffer, Chairperson  
Norman O. Forness, Vice Chairperson  
Elwood W. Christ  
Elizabeth W. Daniels  
David M. English  
Margaret S. Gustafson, Borough Council Liaison  
Walter L. Powell, Historic Preservation Officer

## Illustrations

These two pages: Don Rinehart  
Pages 13 through 15: Betsy Willard  
All other illustrations: Gregory Schaumburg

## Cover Photos:

Front: The first block of York Street, north side, in 1890.  
Back: View looking eastward toward West Street, around 1905.  
Both courtesy of the Adams County Historical Society.

## Special thanks to

David M. English  
*Design Guide Committee Chairperson*

Elizabeth W. Daniels  
*Photography*

Dr. Norman O. Forness  
*History*

Gettysburg Borough Council Members  
*For their support of this project*





**BOROUGH OF GETTYSBURG**  
**ADAMS COUNTY, PENNSYLVANIA**

59 East High Street  
Gettysburg, Pa 17325  
717-334-1160

**A Letter from Borough Council of Gettysburg  
to the Residents and Property Owners  
of the Gettysburg Historic District**

*Dear Fellow Residents and Property Owners,*

*We, the members of Gettysburg Borough Council, together with the members of the Historic Architectural Review Board, are pleased to present you with this manual for the maintenance and care of your historic building.*

*In this booklet you will find information and practical suggestions on a variety of maintenance and rehabilitation projects, ideas you should think about, steps for getting approvals, and hints on where you can go for more help. This information can help make caring for your historic building in our modern world a little easier. We hope you will find it useful.*

*We commend your efforts in preserving our architectural heritage and improving the community, and we look forward to working with you on your upcoming building projects.*

*Sincerely,*

*Gettysburg Borough Council*



1997  
Gettysburg Historic Architectural Review Board

This project was financed in part with federal funds from the National Park Service, Department of the Interior. However, the contents and opinions presented do not necessarily reflect the views or policies of the Department of the Interior, nor does the mention of trade names or commercial products constitute an endorsement or recommendation by the Department of the Interior. This program receives federal funds from the National Park Service. Under Title VI of the Civil Rights Act of 1964 and Section 504 of the Rehabilitation Act of 1973, the U.S. Department of the Interior strictly prohibits unlawful discrimination in departmental federally assisted programs on the basis of race, color, national origin, age, or handicap. Any person who believes he or she has been discriminated against should write to: Director, Equal Opportunity Program, Dept. of the Interior, Nat'l Park Service, PO Box 37127, Wash., DC 20013-7127.

# TABLE OF CONTENTS

## INTRODUCTION

Gettysburg's Architectural History	1
The Big Picture	13
Working with HARB and this Guide	14

## BUILDING MAINTENANCE

Maintaining Your Building	19
Maintenance Checklist	22
Water and Your Building	24

## REHABILITATION GUIDELINES

WOODEN WALLS	25
--------------	----

MASONRY WALLS	31
---------------	----

WINDOWS AND DOORS	39
-------------------	----

PORCHES	49
---------	----

ROOFS	55
-------	----

EXTERIOR COLOR AND PAINT	65
--------------------------	----

COMMERCIAL BUILDINGS AND SIGNS	71
-----------------------------------	----

OUTBUILDINGS, SITE, AND LANDSCAPING	87
--	----

UTILITIES AND ACCESSIBILITY	95
-----------------------------	----

NEW CONSTRUCTION, ADDITIONS & DEMOLITION	99
---	----

## APPENDICES

WHERE TO GO FOR HELP	107
GUIDELINES FOR SIDING	117
PAINT PROBLEMS	119
GLOSSARY	123

# INDEX

## FOR INFORMATION ON      SEE PAGE

Additions	102
Awnings	42, 76
Brick walls	31
Cleaning masonry	33
Demolition	105
Deteriorating wood	26
General building maintenance	19
Gettysburg history	1
More help	107
Mortar	36
New windows	43
Paint colors	67
Paint problems	68, 117
Permits and approvals	16
Porches	49
Ramps	98
Roofs	55
Sandblasting	34
Shingles	58
Shutters	41
Signs	78
Storm windows	47
Vinyl siding	28, 117
Water and your building	24
Wood siding	26
Working with HARB	15





The north side of the first block of York Street around 1890.  
Photo courtesy of Gettysburg National Military Park.

# INTRODUCTION





# GETTYSBURG'S ARCHITECTURAL HISTORY

Though Gettysburg is probably best known today as a major site of the Civil War, it has a distinctive history from the years before and since that conflict. For each period, its architecture reveals important dimensions of local and national currents of taste and culture. In the following sketch of Gettysburg's architectural history, we attempt to identify characteristics of major styles as they came and went nationwide, and the degree to which each was represented locally.

Some of the buildings you see on our streets are clear examples of one historic style or another. However, thrifty and practical Gettysburg citizens often borrowed only some elements of widely popular styles, or they mixed elements of two or more styles in a single structure. You may be surprised to learn that what you consider a very plain house has features common to buildings that represent the highest style of their day.

In the descriptions of Gettysburg's buildings that follow, a number of architectural terms are used. If you aren't familiar with a particular term, look for a photo or drawing on the page for an illustration of it, or turn to the glossary at the end of this guide for its definition.



The house at the southeast corner of S. Washington and W. Middle Streets around 1905. Photo courtesy of Gettysburg Borough.



The house at 53 Breckenridge Street.

# GETTYSBURG'S ARCHITECTURAL HISTORY



A log house at 13 Steinwehr Ave. in 1912. Photo courtesy of Gettysburg National Military Park.



270 South Washington Street around 1925. Photo courtesy of Gettysburg Borough.



The Dobbin House at 89 Steinwehr Avenue.



The Codori House at 46 York Street.

## EARLY GETTYSBURG

The site of Gettysburg was purchased from the Iroquois Indians by the family of William Penn in 1736. Within a few years 150 families lived in the region of Marsh Creek and its tributaries. One settler, Samuel Gettys, established a tavern by October 1761 on a site now in Racehorse Alley behind the building at 26 York Street. By early 1786 his son James had laid out a town of 210 lots and a central town square. Town boundaries lay at current-day Railroad Street to the north, Liberty Street on the east, the alley beyond High Street on the south, and West Street. Within a decade one-fifth of the lots had been sold and thirty-three buildings erected.

In that era most Gettysburg buildings were of log construction, simple dwellings of one or two rooms with a fireplace. While no log structure from within the original town survives, a few erected in the 1830s remain, including those at 53 Breckenridge Street and 270 South Washington Street. Both have been enlarged and clad in siding. In older communities, more elaborate buildings of that era reflected the English tastes of the late colonial period. Popularly known in American architectural history as Georgian, in honor of the British kings of that era, the style was marked by a symmetrical arrangement of elements on its main facade and such details of the Italian Renaissance as classical columns. The Alexander Dobbin house of 1776, located at 89 Steinwehr Avenue, and the Codori house at 46 York Street, built in 1786, both reflect the proportions of Georgian houses. They are handsome stone structures, but neither has the rigid symmetry or decorative details associated with the Georgian. In exterior form they are not different from British and German colonial designs common throughout southern Pennsylvania, and thus they might better be classified as vernacular structures, meaning that they represent popular local building practices.

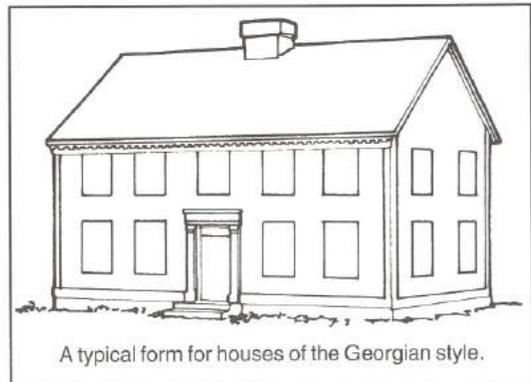

A typical form for houses of the Georgian style.

## GETTYSBURG DURING THE EARLY REPUBLIC

The prevailing taste in architecture nationwide before the Civil War is a broad category known as Neo-classic, though few Gettysburg structures of that era had Neo-classic traits. Neo-classic has a number of sub-styles such as the Federal or Adam style and Greek Revival, the former showing only a modest break with the Georgian. The term Neo-classic means a new approach to understanding the classical world of ancient Greece and Rome. Because of new archaeological finds and developments in scholarship in the late eighteenth century, Greek civilization, though it had preceded the Roman, came to be regarded in the Western world as having a significance comparable to the Roman. Thus, both Greek and Roman elements of style found a place in the new architecture. Porticoes with Greek columns gained popularity, as did the rounded arches and domes of Roman design.

The Federal or Adam style emphasized proportions and symmetry very much like the earlier Georgian, though flat or low-pitched roofs and a greater delicacy in decorative detail set them apart. Both the Georgian and the Neo-classic expressed the new American republic's social and cultural ideals of rationality, harmony, and balance. Semi-circular windows in gables and as fan lights over the main door, placed with keen attention to proportion, marked this style. Two buildings with these windows stand in Lincoln Square -- the Wills House on the east side (1814) and the building on the south side (1818-19).

Greek Revival gained popularity in the 1820s when Greeks revolted against Turkish rule. In 1835 Christ Lutheran Church in the first block of Chambersburg Street emerged with

a modest portico set into a facade that was otherwise not Neo-classic. A somewhat unusual application of Greek Revival detail appears

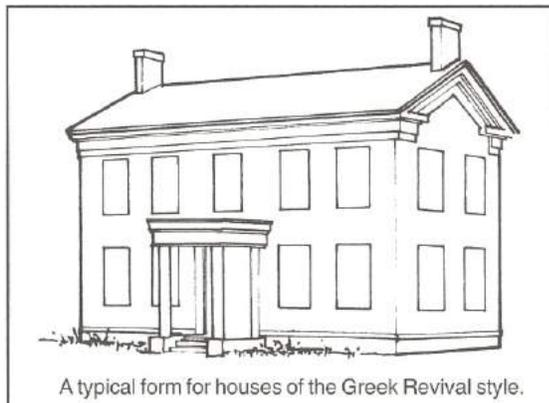

A typical form for houses of the Greek Revival style.

## GETTYSBURG'S ARCHITECTURAL HISTORY



A semi-circular window at 101 West Middle Street.

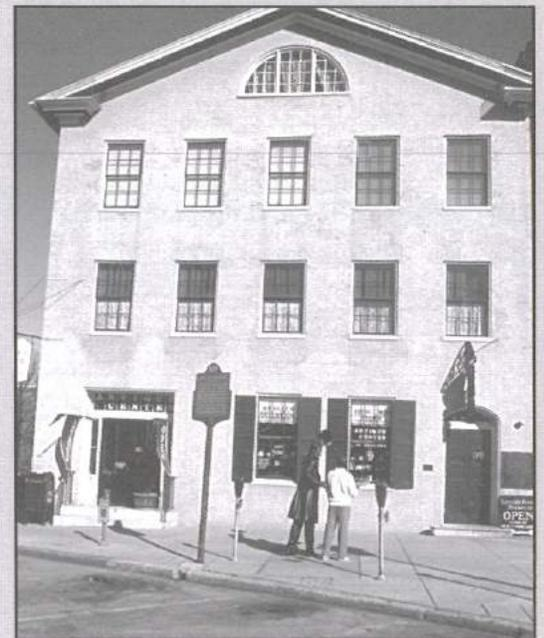

The Wills House on the east side of Lincoln Square.



Christ Lutheran Church on Chambersburg Street.

# GETTYSBURG'S ARCHITECTURAL HISTORY



211-17 Chambersburg Street.



Pennsylvania Hall.



"Twin Sycamores" on Baltimore Street.



423-25 South Washington Street.

at the top of the wall of 211-217 Chambersburg Street, built in 1857. Here, an entablature, a three-layered structure normally placed as a lintel above a row of classical columns, separates the brick wall from the roof.

Its upper part, the cornice, has a row of dentils (small tooth-like projections) and the central portion, the frieze, is punctured with a number of small attic windows. The best Gettysburg example of the Greek Revival, Pennsylvania Hall at

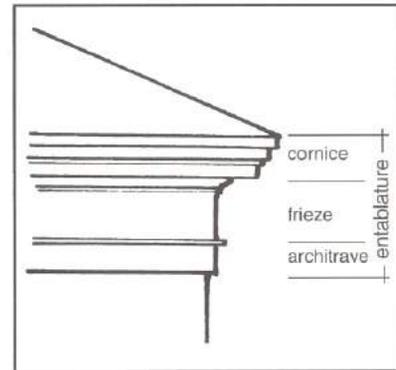

Gettysburg College, built in 1837 from a design of the Philadelphia architect John Trautwein, has an austere handsome portico. It is topped by a plain pediment, a triangular structure giving emphasis to the shape of the portico's gable. The building's cupola is ringed near its top by a delicate design of swags, executed in wood.

Most structures in Gettysburg during the town's first half century revealed simple tastes and modest incomes, but with features common in this region. One such feature, a two-story porch extended along the side of the house under its main roof, appears on houses of various sizes and shapes. Perhaps the most prominently-situated is Twin Sycamores at 404 Baltimore Street, built in 1819. Others in plain view include the houses at 271 Baltimore Street (1834), 303 South Washington Street, and 302 South Washington Street (1875). Because houses of that era normally stand very near each other, such porches are best viewed from alleys.

A similar feature can be found in single-story houses where the eaves extend far beyond the wall, providing protection like that offered by a porch. This feature appears in the house at 425 South Washington Street (1833) and the Jennie Wade house at 520 Baltimore Street (1842).

The neighborhood along South Washington Street, built largely in that era, has many side-gabled structures that reflect a folk interpretation of the Neo-classic in their proportion and massing, but without the decorative details that reveal the style. Even the large residence at

68 West High Street, built in 1813 as an academy, follows common Neo-classic proportions, but with little decorative detail except for its porch and the slender windows around the front door.

Throughout the first half of the nineteenth century Gettysburg continued to grow as a market center by providing services to travelers on the several roads that intersected here. It expanded further as a manufacturing center for wagons. In 1800 it became the seat of the newly created Adams County; and in 1826 its accessibility was a critical factor in its selection as the home of the new Lutheran Theological Seminary. Six years later Pennsylvania (now Gettysburg) College opened here. These evidences of urban sophistication would gradually increase the community's interests in architectural design. At the same time, American society began to depart from its earlier emphasis upon the rational and to give greater accommodation to the emotional side of life, to sentiment, and individualistic expression. This new dimension of culture was known as the Romantic movement and in architecture it found opportunities in a range of picturesque and dramatic styles that flourished in the second half of the century.

## GETTYSBURG, 1850-1900

In 1850 Gettysburg received its introduction to a new style, the Italianate, when Stephen D. Button employed it in his design for the gate house of the new town cemetery. A prominent Philadelphia architect, Button would use the same style in his 1859 design of the new county courthouse at the corner of Baltimore and West Middle Streets. His more eminent Philadelphia competitor, Samuel Sloan, used this style for the new public school on East High Street in 1857. Italianate quickly gained appeal in Gettysburg, as it did elsewhere in the nation. No other style would be used with greater frequency in Gettysburg during the second half of the nineteenth century.

Italianate drew its inspiration from Italian country villas of the early modern era. In massing, Italianate structures were not much different from those of the Neo-classic and might even use classical columns and other classical details. Italianate structures are readily distinguished by windows, often in pairs, with arched tops and crowns,

# GETTYSBURG'S ARCHITECTURAL HISTORY



The Evergreen Cemetery Gate in 1863. Photo courtesy of William A. Frassanito.

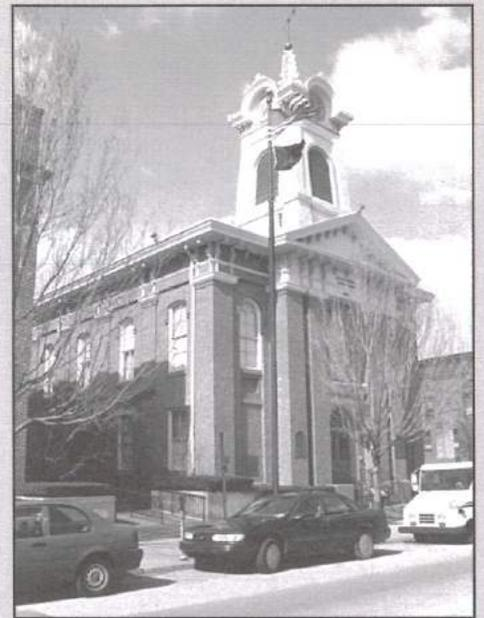

The Adams County Courthouse at 101 Baltimore Street.

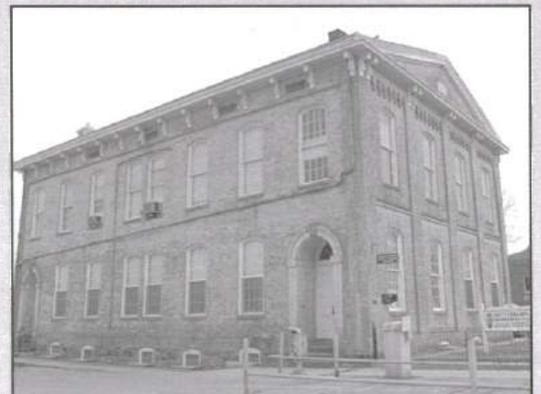

The old High Street School at 40 East High Street.

# GETTYSBURG'S ARCHITECTURAL HISTORY



The Western Maryland Railroad Station on Carlisle St.



The White House on the Gettysburg College campus.



20 Chambersburg Street.



137 South Washington Street.

pronounced decorative elements above the windows. Windows might be flat-topped, but made distinctive by crowns or elaborate framing. Low-pitched roofs had eaves extending outward, under which their designers placed brackets in an amazing array of sizes, shapes, and groupings. Some Italianate structures had cupolas and somewhat square towers. Though Italianate reflected qualities of earlier styles, it offered excellent opportunities for the expression of one's individuality. Thus, this style served well a society becoming increasingly individualistic as popular democracy advanced and industrialization extended entrepreneurial opportunity.

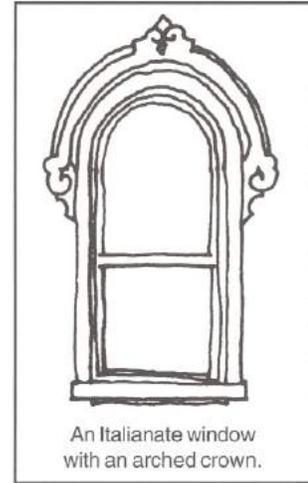

An Italianate window with an arched crown.

In 1858 when the railroad reached Gettysburg, the new station on Carlisle Street emerged as a charming achievement of Italianate design. In 1860 the college provided its president with a new Italianate residence and seven years later its preparatory school on Carlisle Street erected an Italianate structure designed by Philadelphia architect John Fraser. Commercial and residential buildings both employed elements of this style, some in thorough form and others with a modest borrowing of detail. The house at 20 Chambersburg Street (1869) has an eye-catching variety of features, including Gettysburg's most elegant Italianate doorway. Other residential designs of distinction include the houses at 60 York Street (1855), 239 Carlisle Street (1871), 321 Carlisle Street (1870), and the Olinger House (1868) at 137 South Washington Street. Commercial structures include the large Fahnestock Building at 47 Baltimore Street, 139 Baltimore Street, and the Scharf-Bigham building (1880 and 1903) on the east side of the square, now a part of the Gettysburg Hotel.

Italianate came on the scene just before the Civil War, the great turning point in Gettysburg's history. Not only did a major battle of the war make the community known to the world, it altered the local economy. Though the town continued to develop its manufacturing, especially in the production of furniture, the great source of its economic expansion proved to be tourism. As in the rest of the

nation, Gettysburg had a growing middle class and increased wealth. Larger homes, churches, and commercial buildings emerged along its streets and several new neighborhoods developed. Italianate had a flexibility that continued to serve the town's changing fortunes well. The same economic circumstances undergirded the openness of many to find new modes of architectural expression.

In the 1860s many Americans embraced a variation of Italianate popularly known as the French Second Empire style. These buildings had Italianate features plus a mansard roof, which provided an additional story under a steeply-sloped roof, thereby diminishing visually the massiveness of the building. Examples of this design occur at 105 East Middle Street (1870), the Homestead (1869) at 783-785 Baltimore Street, and the house at the southeast corner of South Washington and West Middle Streets.

Gothic Revival, though emerging in the 1830s and 1840s as a challenge to the Neo-classic movement, found no followers in Gettysburg until after the Civil War. A style based on medieval designs, it emphasized the vertical line. Steep gables, often decorated with bargeboards and finials, and windows and doors with tops shaped by pointed arches characterize this style. Gettysburg offers two good examples of Gothic Revival: the small cottage at 115 Chambersburg Street (1867), distinguished by its board and batten walls, and the house at 451 Baltimore Street (1868).

In the post-Civil War years Gothic Revival, with its emphasis on verticality, influenced two new styles: the Stick Style and the Queen Anne. The Stick Style produced tall houses with exposed truss work in the gables or elaborate false cornices, and sharply pronounced strips trimming the windows and the corners of walls. Many had two-story bay windows, rectangular in form. Gettysburg's only example is the striking house at 139 Carlisle Street built for Charles H. Ruff in 1890.

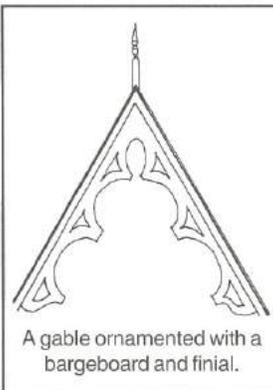

## GETTYSBURG'S ARCHITECTURAL HISTORY



783-85 Baltimore Street.

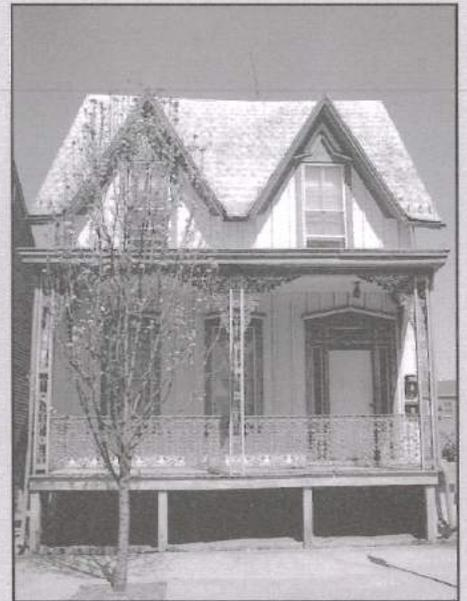

115 Chambersburg Street.



451 Baltimore Street.

# GETTYSBURG'S ARCHITECTURAL HISTORY



139 Carlisle Street.



204 Carlisle Street.



339 Carlisle Street.

The Queen Anne proved far more popular nationwide and also in Gettysburg from the 1880s until the early twentieth century. Though some were modest, extravagance in form and decorative detail seemed to hold a high value with their designers. In an era some have called the Gilded Age, many Americans sought an architecture that served individual distinctiveness in unique ways. Queen Anne served them well. Its structures normally had hipped roofs with cross gables. Gables were often finished in fishscale shingles or marked with half-timbering. Walls could employ patterned brick, stone, clapboards, or combinations of these elements. Bay windows with angled sides, towers with conical tops, tall and elegant chimneys, and porches wrapping parts of two sides appeared on many houses of this design. Porches were often decorated in spindle work, though later renditions of this style incorporated classical columns. Nearly all of them emphasized an asymmetrical massing and their wooden parts were often painted in darker hues and tones.

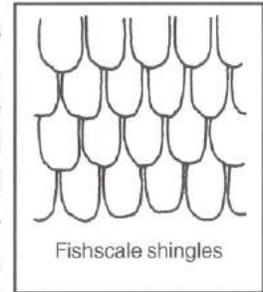

Gettysburg's more notable examples of this style include the houses at 202 and 204 Carlisle Street (1895 and 1893), and the houses at 129 West Lincoln Avenue, 138 West Broadway, and 70 East Stevens Street. The most rich and varied Queen Anne composition stands on the seminary campus at the top of the hill between Springs Avenue and East Middle Street. Designed in 1883 by York architect, John A. Dempwolf, the dramatic effect of its varied surfaces was later lost by painting the entire house a cream color. It also became popular in that era to add Queen Anne features to structures of other styles, and this can be seen in the houses at 329 and 339 Carlisle Street (1869), both mixtures of Italianate and Queen Anne.

The distinctive but less popular Shingle Style drew its inspiration from simple shingle-clad barns of New England. Though these bore some resemblance to the Queen Anne in that they emphasized the natural color of their materials, their towers were more squat, their porches looked heavier, and they lacked extended eaves. Gettysburg's sole example stands at 311 Carlisle Street, an 1890 design by John Dempwolf. Its natural shingle look has now been altered by cream-colored paint.



The Romanesque Revival style of the later decades of the nineteenth century produced structures drawing upon the designs of early medieval Europe. Popularized by Boston architect H. H. Richardson, these structures had a massive appearance, usually executed in large, rough stones. Their short, rounded arches at doorways and over windows emphasized heaviness and power. The tower of Glatfelter Hall at Gettysburg College reflects this style well, though much of the rest of the building is more in the Queen Anne mode. John Dempwolf designed this building and the similar Brua Hall for the college in 1888-1889.

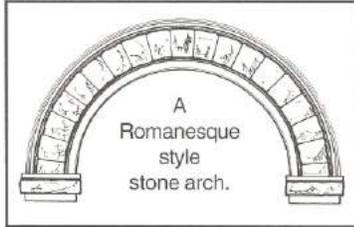

## 20TH-CENTURY GETTYSBURG

The end of the nineteenth century brought a style known as Colonial Revival. Early versions of this style placed classical features associated with Georgian design on asymmetrical buildings, as in the case of the Singmaster House (1901) on the seminary campus. Increasingly, Colonial Revival copied the careful proportions and symmetry of Georgian. Doorways in this style might be surrounded by elaborate framing or sidelights, often with one of several variations of pediments above the main door. Small gables, each for a single window and often pedimented, added distinctiveness to the roof. Dutch Colonial designs incorporated the same features, though with a steep gambrel roof.

This style remained popular, especially in the Eastern United States, until World War II. Its formal street facade has continued to appeal until the present day to many who build new houses. Gettysburg's earlier applications of this style appear in many locations. Good examples include the twin brick houses at the northwest corner of West Broadway and North Washington Streets, the frame house on the southeast corner of the same intersection, and 231 and 244 Springs Avenue. A Dutch Colonial design distinguishes the house at 43 West Broadway. In the first block of Chambersburg Street, the James Gettys Hotel handsomely incorporates this style into an older commercial structure. The seminary chapel, designed in 1940 by J. Alfred Hamme of York, provides a beautiful ecclesiastical example of the Colonial Revival.

# GETTYSBURG'S ARCHITECTURAL HISTORY



311 Carlisle Street.



Brua Hall on the Gettysburg College Campus.



244 Springs Avenue.

# GETTYSBURG'S ARCHITECTURAL HISTORY



Breidenbaugh Hall on the Gettysburg College campus.



The Adams County National Bank building on Lincoln Square.



The Epley Building at 100 Chambersburg Street.

The Classical Revival style of the early twentieth century bears a close relationship to the Colonial Revival. It is distinguished by porch columns that rise to the full height of the building. Breidenbaugh Hall, built in 1925 on the college campus at the southwest corner of North Washington and West Lincoln Avenue, demonstrates this characteristic with a pediment above the columns. The Adams County Library at 140 Baltimore Street (built as the Post Office in 1914) has a similar application of columns, though without a pediment. A variation on the two-story porch appears on the residence at 222 Springs Avenue, which has a semicircular porch of a single story. The Beaux Arts movement of the same era was also related to the classical tradition, normally using its features. The Beaux Arts, bearing the name of a school of design in Paris, emphasized compositions of harmony which depended on the mass of the buildings. These grand, well-decorated structures were popular for large public buildings. The Adams County Bank at the west side of the square (1919) and the Epley Building at 100 Chambersburg Street (1916) reveal the influence of Beaux Arts design.

In the early twentieth century bungalows also gained popularity, though not in the East as much as on the West

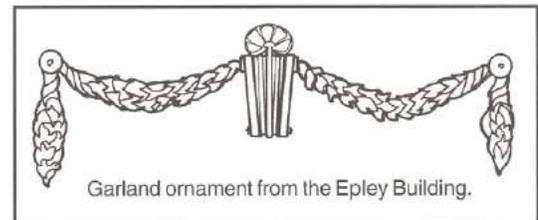

Garland ornament from the Epley Building.

Coast. Derived from houses developed in British India, these structures often combined a variety of construction materials and had exaggerated, over-hanging eaves, often exposing the ends of the rafters. Their large roofs often had gabled or shallow shed roofed dormers. Heavy elements characterized the support structure of their deep porches. Good examples of these houses in Gettysburg stand at 200 South Stratton, 243 Springs Avenue, and 520 West Middle Street. That area of West Middle Street provides several examples of bungalows.

One of the locally-popular designs for residences in the early twentieth century, the so-called four-square house, might draw features from the Colonial Revival or even the bungalow, though decorative details were not necessarily characteristic of such houses. Two-story structures built on a simple rectangular form and usually capped with a hipped roof were economical and comfortable. Often they

had broad front porches, with the main entrance at one side of the porch. These houses were built frequently in all parts of Gettysburg in the earlier decades of the twentieth century. Good examples appear at 225 and 237 Springs Avenue and 118-120 Hanover Street. The first block of East Lincoln Avenue has several two-family houses in four-square design.

The years between the two world wars saw also the emergence of Tudor structures. The name refers to the late Gothic-early Renaissance designs of Tudor England, the age of Henry VIII and Elizabeth I. Structures in this style had such features as steep roofs, multi-paned windows, half-timbered gables, and occasionally doors with rounded tops. Houses at 145 West Broadway and 145 Seminary Avenue have some of these features, as does the building at 35 Chambersburg Street, adjacent to the James Gettys Hotel.

In the years after World War II, American residential architecture tended to follow the popular trend toward less formality in social life. Houses designed for comfort and casual patterns of living made the one-story ranch house appealing everywhere. The ranch house lacked adherence to historic models of architectural design, its horizontal profile making many stylistic details of the past difficult or impossible to apply.

Though designers might choose to include adaptations of past styles on such single-story houses, they normally succeeded in doing so only on two-story structures. Eventually, the broad appeal of the rancher diminished, and by the later years of the century Americans were building from a broad array of designs, often reviving a variety of elements of past styles.

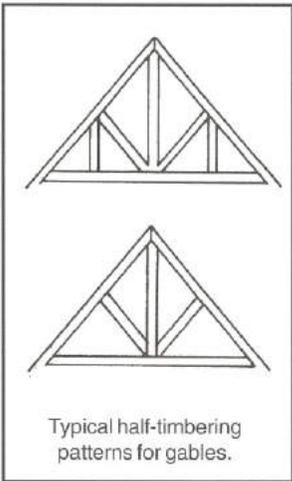

For the borough of Gettysburg, the same trend proved true. The largest new section of the post-war years, Colt Park, emerged on the southern edge of the community. Here, houses reveal a wide variety of designs, many of them single-story structures influenced by the ideals of the rancher. Because so much of the town is surrounded by Gettysburg National Military Park, most of the construction of recent decades has occurred beyond its corporate limits. Whether within the borough

# GETTYSBURG'S ARCHITECTURAL HISTORY



351 West Middle Street.



124 Springs Avenue.



145 West Broadway.



293 Fourth Street.

# GETTYSBURG'S ARCHITECTURAL HISTORY

---



Fairview Avenue.



The Heritage Motor Lodge.

or in its surrounding neighborhoods, the free adaptation of traditional stylistic elements or the disregard of such features have characterized construction. Today, as in the early years of the community, much of what is built can best be called vernacular design. High style has always had a somewhat limited appeal in Gettysburg. Nevertheless, with more than two centuries of development, the community has a rich heritage of popular expression in modes of building and taste. Given the town's place in the nation's history, its buildings in all their variety constitute a defining element in the story of the community and its relationship to American culture.

## WHY HAVE DESIGN GUIDELINES?

Older buildings were not constructed the way buildings are today, and some of today's methods for dealing with modern buildings can damage or otherwise compromise historic buildings. Unfortunately, this information isn't always common knowledge. As a result, unregulated construction activity can ruin the most significant features of our historic buildings and the most valued qualities of our historic community, simply because people are unaware that different -- often better -- methods exist for dealing with their buildings. Design guidelines can prevent this hasty and thoughtless destruction and alteration of historic buildings by identifying significant buildings and features, by outlining preferred options, and by specifying appropriate treatments. By presenting this information along with a wealth of practical advice, this design guide acts as a standard to be followed in the review process. As such, it is valuable to the Borough, to the Historical Architectural Review Board, and to property owners.

The use of design guidelines can also have an economic impact. Gettysburg depends to a large degree on tourists for its economic survival. Each and every building in the borough plays a significant part in this economy. Tourists come to Gettysburg for many reasons, but if the historic character of Gettysburg's buildings is lost, the day will come when fewer tourists visit downtown Gettysburg. Tourism not only affects the business owners of the borough, it also affects the residential property owners -- tourists bring in money that helps support the whole town and helps keep taxes down. Consequently, property owners who make their buildings stand out by making changes that are inappropriate to the character of the historic district may enjoy a short-term gain, but over time can contribute to the decline of a strong economy through the destruction of the physical environment on which it was based.

Final responsibility for maintaining buildings and planning for their long-term survival rests with the individual property owner, and the process of design review works best with the owner's active and early participation.

Design guidelines can be useful tools for achieving creative solutions that allow the modern use of historic buildings. But, beyond this immediate goal, the use of design guidelines can also help protect property values and quality of life, and can help ensure the livability of our community for generations to come.

## THE BIG PICTURE

The character and appearance of a community demonstrate the values and attitudes of its residents. A community's appreciation of its heritage is demonstrated through its attitude toward historic preservation.

In 1972 the Borough of Gettysburg officially recognized the value of its historic buildings and the need for their protection with the adoption of the Gettysburg Historic District Ordinance. To carry out its goal, the Ordinance established a Historic Architectural Review Board and a process for design review.



# WORKING WITH HARB & THIS GUIDE

## The Secretary of the Interior's Standards for Rehabilitation

*The guidelines listed below were developed by the U.S. Department of the Interior. They are accepted nationwide as the standard for rehabilitating historic buildings, and are used by the Gettysburg HARB.*

1. A property shall be used for its historic purpose or be placed in a new use that requires minimal change to the defining characteristics of the building and its site and environment.
2. The historic character of a property shall be retained and preserved. The removal of historic materials or alteration of features and spaces that characterize a property shall be avoided.
3. Each property shall be recognized as a physical record of its time, place, and use. Changes that create a false sense of historical development, such as adding conjectural features or architectural elements from other buildings, shall not be undertaken.
4. Most properties change over time; those changes that have acquired historic significance in their own right shall be retained and preserved.
5. Distinctive features, finishes, and construction techniques or examples of craftsmanship that characterize a property shall be preserved.
6. Deteriorated historic features shall be repaired rather than replaced. Where the severity of deterioration requires replacement of a distinctive feature, the new feature shall match the old in

(continued  
on next  
page)



## USING THE GETTYSBURG DESIGN GUIDE

**WHAT IS IT?** This design guide is a **tool**.

**WHO IS IT FOR?**

- Property owners.
- Design professionals.
- Contractors.
- HARB.
- Borough Council.

### WHAT DOES IT DO?

It helps manage change and protect historic and architectural resources in the Gettysburg Historic District.

### HOW DOES IT WORK?

- These guidelines are not meant to be rigid restrictions. They are meant to be used as guiding principles that, when followed, will result in the sound preservation of Gettysburg's historic buildings.
- As a property owner, you are encouraged to review this manual when **planning** changes to your property. Early consultation with the Historic Preservation Officer and HARB will provide for the most flexibility in planning your project.

### WHAT'S IN IT?

#### 1 An Architectural History of Gettysburg.

Read the history (it precedes this section), then go outside and look closely at your building. Try to identify its style, its period of construction, and its important features. If you get stuck, the borough's Historic Preservation Officer can help.

#### 2 A Maintenance Checklist.

Routine maintenance is the key to extending the life of your building. Review the chapter (it's short!), then take a copy of the checklist outside to inspect your building. Don't wait -- you can catch problems before they start.

#### 3 Information Arranged by Building Part.

Most of the information in this booklet is divided into chapters arranged by building part. You'll find chapters on walls, roofs, windows and doors, porches, and paint. There are also chapters on additions, new construction, and demolition, and on utilities and accessibility. Be sure to read the chapters that cover the types of projects you're planning. For example, if you've been thinking that your porch needs some work, go to the porch chapter. All of the chapters cover important information, so you'll want to read them, too.

#### 4 More Help!

Go to the Appendices at the end of this booklet for definitions of technical terms and for lists of additional publications and organizations that can help you with your projects.

## WHAT IS HARB?

HARB is an advisory body created by state and local laws and appointed by Borough Council. It is composed of seven members including an architect, a real estate broker, the Borough's Historic Preservation Officer, and four people with an interest in the preservation of Gettysburg's historic buildings. HARB's main responsibility is the review of all proposals for new construction and all changes to the exteriors of buildings located in the Gettysburg Historic District. HARB reviews this work to protect the architectural and historical character that makes Gettysburg a unique place, which in turn contributes significantly to the quality of life in the Borough.

## HOW DOES HARB MAKE ITS DECISIONS?

Prior to the regularly scheduled HARB meeting, HARB members review each application and visit each property in question. HARB assesses the architectural and historical significance of the property, and considers the effect of the proposal on the overall district, on the street, and on the individual building and its component features. To help make its decision, HARB applies the *Secretary of the Interior's Standards for Rehabilitation*, which are listed in the sidebars on these two pages. These guidelines were developed by the United States Department of the Interior following several decades of preservation activity. They are accepted as the national standard for rehabilitating historic buildings.

In determining the compatibility of the proposed project, HARB also considers a number of issues specifically identified in Gettysburg's Historic District Ordinance, such as proportions, window placement, and materials. This design guide clarifies these matters, and provides information in greater detail than is given in the ordinance. Consequently, this Design Guide is an important tool that HARB can use in its decision making process.

After HARB has considered all of these materials and issues, it votes on the proposal and sends its recommendation to Borough Council. Borough Council makes the final decision on the application, using the same information as HARB in its determination.

## WORKING WITH HARB

### The Secretary of the Interior's Standards for Rehabilitation (continued)

design, color, texture, and other visual qualities and, where possible, materials. Replacement of missing features shall be substantiated by documentary, physical, or pictorial evidence.

7. Chemical or physical treatments, such as sandblasting, that cause damage to historic materials shall not be used. The surface cleaning of structures, if appropriate, shall be undertaken using the gentlest means possible.
8. Significant archaeological resources affected by a project shall be protected and preserved. If such resources must be disturbed, mitigation measures shall be undertaken.
9. New additions, exterior alterations, or related new construction shall not destroy historic materials that characterize the property. The new work shall be differentiated from the old and shall be compatible with the massing, size, scale, and architectural feature to protect the historic integrity of the property and its environment.
10. New additions and adjacent or related new construction shall be undertaken in such a manner that if removed in the future, the essential form and integrity of the historic property and its environment would be unimpaired.

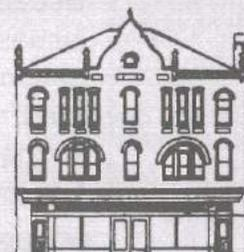

# WORKING WITH HARB

## HARB DOES NOT REVIEW:

- Interior work
- Regular maintenance that does not require the replacement or change of materials
- Repainting or paint color
- Change in use

## WHAT PROJECTS DOES HARB REVIEW?

HARB reviews any projects, including alterations, additions, new construction, and demolition, that can be seen from a public street, alley, or other public space. Some of the typical types of projects that HARB reviews are listed below. (This list is not all inclusive.)

- ⇒ Additions
- ⇒ Alterations
- ⇒ Awning installation and changes
- ⇒ Cleaning exterior surfaces with abrasive methods
- ⇒ Colors of permanent building features (roofs, artificial siding, etc.)
- ⇒ Cornice changes
- ⇒ Demolition
- ⇒ Door changes
- ⇒ Fences
- ⇒ Masonry work
- ⇒ Materials replacement
- ⇒ Moving of buildings
- ⇒ New construction
- ⇒ Parking areas
- ⇒ Porches
- ⇒ Reconstruction
- ⇒ Removal of architectural details or ornamentation
- ⇒ Renovation (exteriors)
- ⇒ Restoration
- ⇒ Roofing
- ⇒ Siding
- ⇒ Sign design, installation and changes
- ⇒ Skylights
- ⇒ Stairs (exterior)
- ⇒ Storm doors and storm windows
- ⇒ Window changes

## HOW CAN HARB HELP PROPERTY OWNERS?

Because HARB members have specific expertise and interest in issues related to old buildings, HARB can often come up with options for treating properties that owners may not have considered. HARB may also be able to provide property owners with suggestions for treatments that cost less and make their properties look better.



# CERTIFICATES OF APPROPRIATENESS

## WHAT ARE THEY?

A Certificate of Appropriateness is a permit approved by HARB and issued by Borough Council. It certifies that a proposed change is appropriate to the character of a building in the historic district and to the historic district as a whole.

## OBTAINING A CERTIFICATE OF APPROPRIATENESS

The process for obtaining a Certificate of Appropriateness is a simple one. It begins when a property owner applies for a building permit. If the building permit officer finds that the property is in the Historic District, the application is forwarded to the Historic Preservation Officer.

An application can be obtained from the Historic Preservation Officer (HPO), whose office is on the second floor of the Municipal Building at 59 East High Street. Fill out the form in as much detail as possible. You may need to include photographs, slides, drawings, and/or material samples with your application, depending on the type of work you are proposing. The HPO will tell you what is required for your project. The Certificate process is summarized in the flow chart on the next page. Important dates in the application and review process are summarized below.

### IMPORTANT DATES TO KNOW

S	M	T	W	T	F	S
1	2	3	4			7
8	9	10				14
		17	18	19	20	21
			25	26		
29	30					

**APPLICATIONS DUE  
12:00 NOON  
3RD FRIDAY  
OF THE MONTH**

**BOROUGH COUNCIL  
MEETING  
7:30 PM  
2ND MONDAY OF  
THE MONTH**

**HARB MEETING  
7:30 PM  
4TH WEDNESDAY  
OF THE MONTH**

# WORKING WITH HARB

## Changes Without Approval

If a property owner initiates work without a building permit and a Certificate of Appropriateness, a stop work order may be issued and the owner may be required to pay a fine if requirements are not met.

## Other Regulations

In addition to needing a Certificate of Appropriateness for work in the Historic District, properties are also subject to the regulations of Gettysburg's Zoning Ordinance, Sign Ordinance, and Building Codes. For more information, contact the Borough's Zoning Officer at 334-1160. Construction in the borough also requires a county building permit. Call 334-6781 for more information.

## Working with Contractors

Working with contractors can be both frustrating and rewarding. If you choose to use a contractor rather than undertaking your project yourself, be sure to choose a contractor who has successfully completed projects similar to yours and one who has experience with old buildings. If a contractor tells you it is impossible to replace historic materials in kind or that your old building can't be saved, get a second opinion. Check references and inspect completed projects before choosing your contractor. Get at least three detailed estimates from different contractors, and always be wary of unusually low estimates. Your best defense against shabby and inappropriate work is knowledge. Learn everything you can about the work to be done, even if you won't be doing the work yourself, then regularly monitor the work as it progresses. The information in this manual and the sources listed in the Appendix can help you considerably.

# WORKING WITH HARB

## OBTAINING A CERTIFICATE OF APPROPRIATENESS IN GETTYSBURG

All changes to the exterior of a property in the Gettysburg Historic District must be approved by HARB. This includes alterations and additions to buildings, new construction, and installation of signs, awnings, and fences.

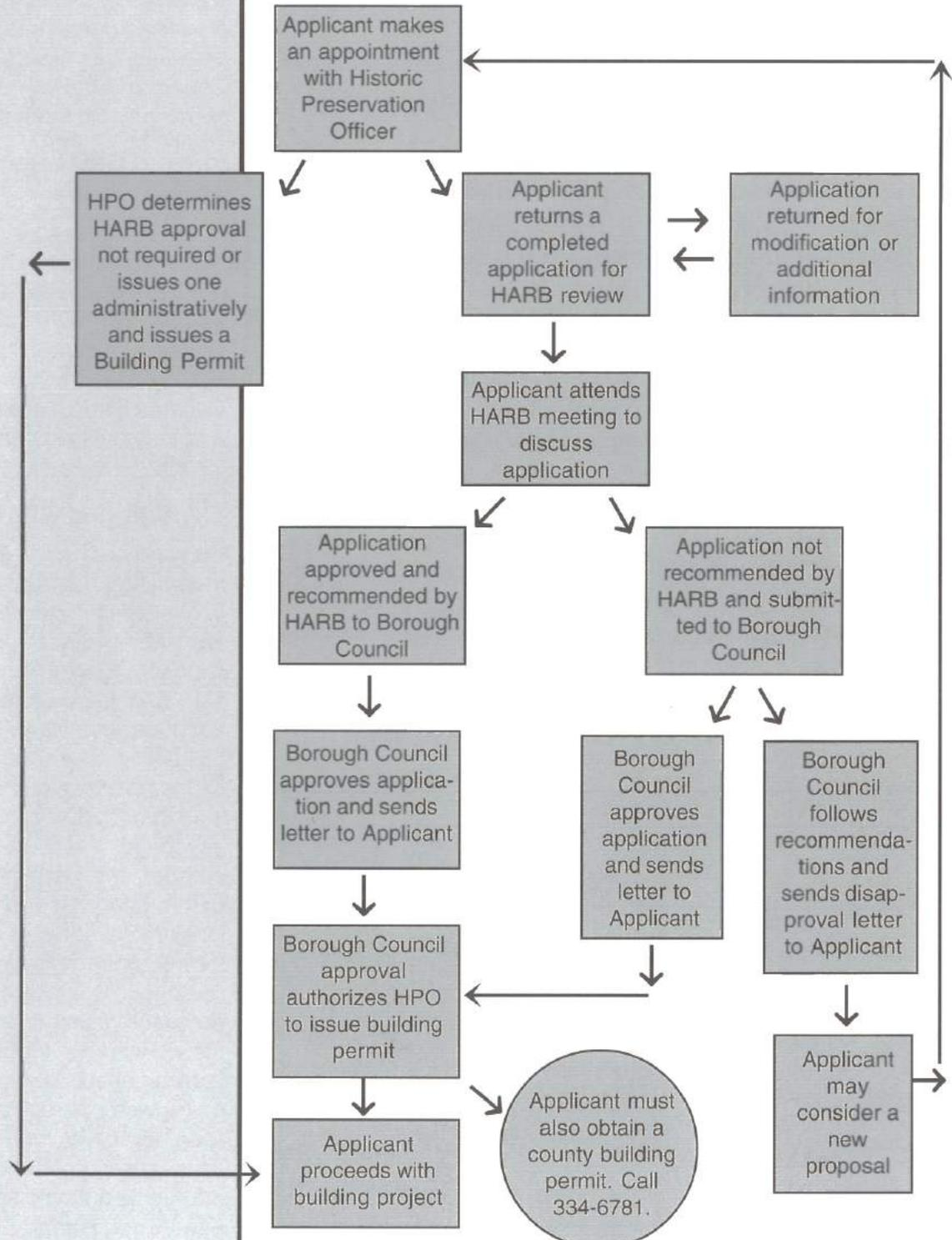

# BUILDING MAINTENANCE



1915 view of the ca. 1797 stone building that previously stood on the site of the addition to the Adams County National Bank. Photo courtesy of Gettysburg National Military Park.



# MAINTAINING YOUR BUILDING

## TYPICAL AREAS THAT REQUIRE MAINTENANCE IN A WOOD FRAME HOUSE

All Gettysburg structures are made of building materials that deteriorate over time — a long-term process caused by the effects of rain, wind, sunlight, and temperature changes, by chemicals in the atmosphere, and by insects, birds, rodents, and vegetation.

Degrees of deterioration vary, and not all deterioration requires replacement of historic material. Historic structures have survived in Gettysburg for decades, and with proper treatment, they can continue to survive for decades more — in many cases lasting longer than modern buildings.

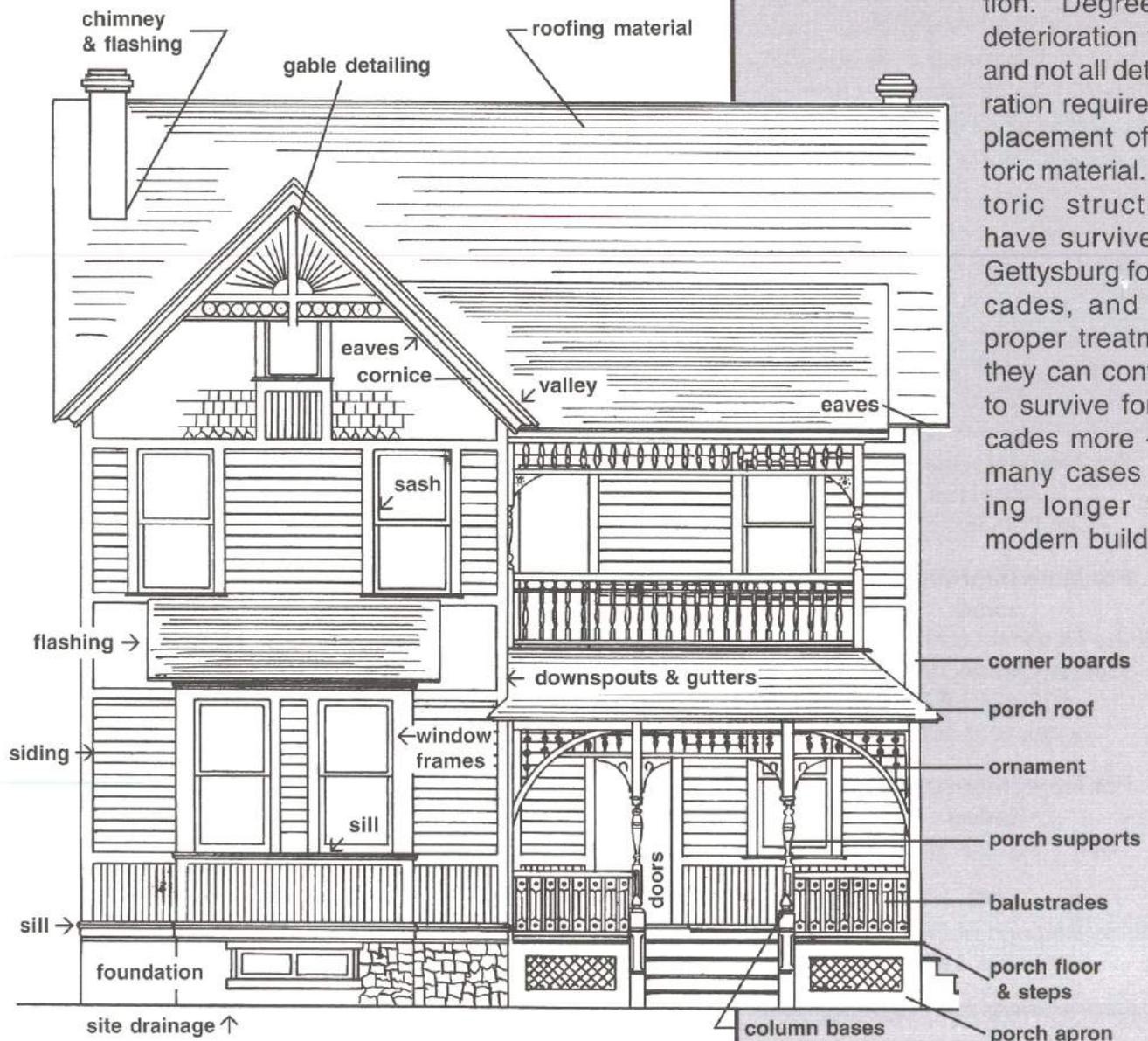

A nineteenth century drawing by M.E. Stallsmith. Courtesy of the Adams County Historical Society.

# MAINTAINING YOUR BUILDING

## Safety First

Maintaining and rehabilitating buildings can be enjoyable and rewarding. But safety precautions should always be taken with all tools, materials, and processes used. It is always wise to carefully read all manufacturers' directions and to consult a professional on work that is unfamiliar. In addition, work on old buildings can bring asbestos and lead to the surface. Because these materials can cause health problems, it is a good idea to be familiar with them before beginning your maintenance or rehabilitation projects.

### For More Information on Asbestos

Call 800-368-5888.

### For More Information on Lead

Call the National Lead Information  
Center Clearinghouse at  
800-424-LEAD  
or call your doctor.

### For More Information on Radon

Call 1-800-23-RADON.

### OR

Call the Borough of Gettysburg at  
717-334-1160.

## PREVENTIVE MAINTENANCE

The key to the survival of the buildings of Gettysburg — old or new — is PERIODIC INSPECTION followed by REGULAR MAINTENANCE.

Many property owners in Gettysburg perform maintenance only after something fails. This approach offers little protection for the building. Periodic inspection is designed to identify problems before they cause significant damage. This is followed by scheduled regular maintenance that will stop minor deterioration that has already begun and, in the long run, will provide the easiest and least expensive way to maintain the appearance and overall physical condition of your building.



Building maintenance at 147 Carlisle Street.

The checklist in this section can help record the condition of your building and keep track of maintenance tasks as they are performed. This checklist is only meant as an example — you may develop one more appropriate for your property.

It is best to perform your inspection during a moderate rainfall; this allows for the best assessment of your roof and overall drainage systems. Binoculars can assist in evaluating parts of your house that are out of reach. A thorough inspection of the interior is also recommended. This is particularly true of the roof, where a leak identified in the attic can help pinpoint the location of failing exterior roof materials.

Throughout your house, visible damage in one area can be caused by a problem originating somewhere else — so look carefully. And REMEMBER: Although repairing problems yourself may be less expensive, it is usually best to seek professional assistance for major maintenance and rehabilitation work.

## MAINTENANCE CODES AND DEMOLITION BY NEGLECT

Sometimes, a property owner abandons a building or allows a building to be occupied, but without the benefit of maintenance. This deliberate lack of maintenance, which leads to the eventual destruction of the building, is called *demolition by neglect*. Demolition by neglect is not only wasteful, it is in violation of the Borough's codes. In 1985 the Borough of Gettysburg adopted the *Building Officials and Code Administrators (BOCA) National Property Maintenance Code* to protect the public health, safety, and welfare by regulating the maintenance of structures and exterior properties in the Borough. For more information on the Property Maintenance Code, contact the Borough's Code Enforcement Officer at 334-1160.



A building undergoing maintenance at 233 South Washington Street.

### Remember:

There are **NO** miracle treatments or products that will ensure the preservation of a structure — new or old — without maintenance and repair.

## MAINTAINING YOUR BUILDING

### The Borough Maintenance Code Regulates the Condition and Maintenance of these Lot Components:

- grading and drainage
- sidewalks and driveways
- weeds
- exhaust vents
- accessory structures
- motor vehicles

### The Code also addresses:

- sanitation
- rodents

### The Code requires that the exteriors of structures be kept sound and sanitary. It regulates:

- street numbers
- structural members
- foundation walls
- exterior walls
- roofs and drainage
- decorative features
- overhang extensions
- chimneys and towers
- handrails and guardrails
- window and door frames
- insect screens and doors
- basement hatchways
- window guards

# PREVENTIVE AND CYCLICAL MAINTENANCE CHECKLIST

## WHAT TO LOOK FOR

### ROOF

**Materials:**

Warping, severe wear, cracking, lumps, curling, decay, splitting, rusting, loose pieces, missing pieces, broken pieces, thin material.

**Structure:**

Is the roof level, or does it sag?

**Roof flashing, gutters, downspouts:**

Rusting, paint loss, sagging, missing, or torn pieces, blockages, poor drainage.

**Decorative elements (finials, cresting, etc.):**

Loose pieces, rust, missing pieces, deteriorated cornice.

**Chimney and parapet:**

Is the chimney sagging, leaning, or bowing? Are the mortar joints tight? Is the chimney cap rusting or missing? Are bricks loose or missing?

### EXTERIOR WALLS

**Structure:**

Are the walls leaning, bowing, or bulging? Are cracks evident? Are the door and window openings square?

**Materials:**

Is the surface of masonry or stucco flaking, crumbling, or are units missing?

Is the mortar loose, crumbling?

Is the wood siding cracked, loose, rotted, or split? Do courses of siding appear straight or wavy?

Is cast iron or pressed metal rusting, pitted, or missing?

Are the walls stained?

Is paint peeling, cracking, blistering, or chalking?

**Porch floors:**

Cracks, splits, loose boards, missing boards, rot.

**Decorative elements:**

Peeling paint, cracks, loose pieces.

*Perform this maintenance check once each year, preferably during a moderate rainfall.*

## ESTIMATED LIFE SPAN & REPAIRS REQUIRED

- Metal roofing: repair and paint every 5-10 years. Others: 20-50 years.
- Re-secure, reattach, replace loose or missing pieces.

- Check rafters for deterioration, moisture penetration.
- A dry, properly maintained roof structure should last indefinitely.

- Re-nail and/or add gutter hangers as necessary.
- Clean gutters in the spring and fall.
- Check elbows for packed material. Caulk cracks. Remove rust and repaint. Repair holes with roofing cement, solder, caulk, etc.

- Repair and repaint elements every 5-10 years.
- Check for moisture infiltration.

- Pointing should last 50 years or more.
- Repointing required periodically in limited areas.

- Dry, properly maintained wall structure should last indefinitely.
- Check foundation for settling.

- Masonry units can last for centuries with proper maintenance.
- Address moisture problems promptly.

- Pointing should last 50 years or more.
- Masonry may require periodic repointing in limited areas.
- Check for moisture infiltration.

- Replace clapboards every 150 years.
- May require periodic reattachment, partial replacement.
- Work to limit moisture infiltration.

- Painted surfaces may require repainting every 5-10 years.

- Clean masonry only when necessary as part of stabilization work.

- Paint previously painted masonry surfaces approximately every 10 years.
- Repaint wood surfaces every 5-8 years.

- Wood floor boards should last 50 years or more.

- Paint every 5-8 years.



*The primary objective of building maintenance is the elimination of openings that allow water to penetrate the building. Proper ventilation is also required.*

---

### ESTIMATED LIFE SPAN & REPAIRS REQUIRED

---

- Windows should last 100 years or more.
- Doors, properly treated, should last indefinitely.
- Check for settlement.
- Repaint every 5-8 years, as necessary depending on weathering.
- Excessive paint buildup can cause windows and doors to "stick."
  
- Window glass should last indefinitely.
- Repair broken glass immediately to guard against water infiltration.
  
- Check for water infiltration.
- Paint every 5-8 years, depending on weathering.
- Perform periodic repairs and limited parts replacement as required.
- The sill may require repair/replacement before other frame members.
- Check for water penetration.
- Threshold may require repair/replacement before other elements.
- Check for settlement.
- Caulk as necessary.
  
- Hardware, properly treated, should last indefinitely.
- Sash cords may require replacement.
  
- Putty should last 10-15 years.
- Caulking should last 15-20 years.
- Periodic repairs to weatherstripping, caulking, and putty may be necessary.
- Clean and mend screens and storm windows annually.

---

Guard against water infiltration.

Repaint every 5-10 years, depending on surface and conditions.

---

- Properly maintained masonry should last indefinitely.
- Guard against water infiltration.
- Pointing should last 50 years or more.
- Repointing may be required periodically in limited areas, or following water-related repairs.
  
- Check for settlement.

Remove vegetation as required and sources of excess moisture.

- Check for movement; replace as necessary.
- Check that drainage is away from building.

## PREVENTIVE AND CYCLICAL MAINTENANCE CHECKLIST

---

### WHAT TO LOOK FOR

---

#### WINDOWS AND DOORS

**Operation:**

Do windows and doors open and close smoothly?

**Glass:**

Is the glass broken? Is the glazing secure? Do the glass panes fit securely? Are the stops and putty secure?

**Frames, etc.:**

Do the frame, muntins, sash, and door show signs of rust, rot, or insect damage?

Is the threshold rotted?

Are there open joints around the frames/trim?

**Hardware:**

Is the hardware operational and in good repair?

**Weatherization:**

Is the weatherstripping in good repair? Do storm windows fit tightly? Are the screens damaged?

#### EXTERIOR FEATURES

**Exterior Elements:**

Are porches, stairs, railings, cornices, brackets, and other exterior features in good repair? Are elements missing?

**Paint:**

Is the paint cracked, faded, or peeling?

#### FOUNDATION

**Masonry:**

Does water drain away from the foundation? Is masonry flaking, crumbling, spalling, cracking? Is masonry loose or missing? Is the mortar secure?

**Structure:**

Is the wall bulging or bowing?

**Vegetation:**

Are algae, moss, vines growing on the foundation?

**Water Control:**

Do downspouts have splash blocks?

# WATER AND YOUR BUILDING

## How Insulation Can Add Moisture to Your Building:

- In cold weather, the air inside your home is warm and moist. It tends to travel through the exterior walls of your house, to the cold outside. As it travels to the cold air, it turns to water in the form of condensation.
- When insulation is installed without a barrier, condensation remains in the cavity of the wall where it can deteriorate cellulose insulation, wall structure, & wall coverings, including exterior siding & paint, and interior paint & plaster.
- If you install insulation, you can prevent condensation and deterioration by installing a vapor barrier. Install the vapor barrier on the exterior side of the inside (heated) wall.
- The same principle holds true for the floors of unheated attics, where the vapor barrier should be placed **down** (closest to the heated ceiling below).
- The same holds true for unheated basement or crawl space ceilings, where the vapor barrier should be placed **up** (closest to the heated floor above).

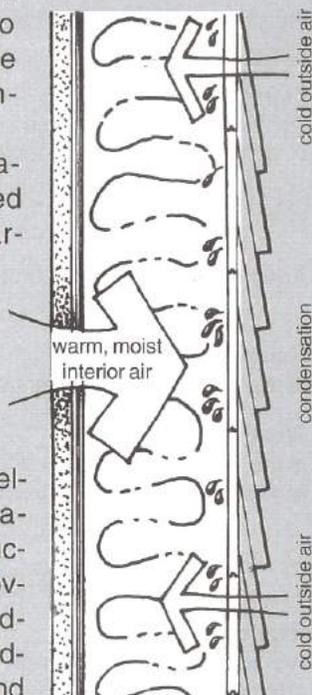

## THE MOST POWERFUL FORCE OF DETERIORATION AGAINST YOUR BUILDING IS WATER.

Water can cause wood to rot, bricks and stones to crumble and fall, and paint to blister and peel. The information below can help identify some of the causes of moisture problems in buildings, which is the first step to reducing moisture-related damage. (See the Wood Walls, Masonry Walls, and Exterior Color and Paint chapters for more information.)

### You Probably Have a Moisture Problem If You See:

- Bricks or stones with surface layers falling off
- Bricks or stones falling from the wall
- A masonry wall that is covered with plant growth
- A spotty white haze on brick or stone (efflorescence)
- A painted surface that is peeling down to bare wood
- Paint that is blistering
- Paint that is covered with mildew
- Damage to interior floors, plaster, drywall, or paint
- Increased interior relative humidity
- Moss or plant growth on shingle roofs

### Where Does Excess Moisture Come From?

- Leaking or inadequate gutters, downspouts, flashing
- Missing or damaged shingles or other roof materials
- Defective caulking, sealants, and/or expansion joints
- Damaged masonry, for example, from sandblasting
- Missing or damaged wall material (like cracks in siding)
- Inadequately treated walls (like unpainted siding)
- Faulty mortar joints
- The growth of ivy or other vegetation
- Poor drainage at the foundation
- Rising damp (suction pulls groundwater up through a masonry wall)
- Insufficient ventilation of interior moisture

### Possible Treatments to Guard Against Moisture:

- Treat new and replacement wood with a preservative that kills fungi before painting.
- Use marine epoxy products for minor deterioration. They saturate the wood, arrest the rot, and fill all damaged areas.
- Consider damp proof courses and below grade waterproofing with the assistance of a professional.

### For Additional Ways to Reduce Moisture:

- See the information on excess moisture in the Exterior Color and Paint chapter of this guide.



The first block of Chambersburg Street around 1890.  
Photo courtesy of Gettysburg National Military Park.

# REHAB GUIDELINES





Buildings in the 300 and 400 blocks of S. Washington Street, looking north, around 1884.  
Photo courtesy of the U.S. Army Military History Institute.

# WOODEN WALLS



## EXTERIOR WALLS of WOOD

Wood is a surprisingly durable material. Properly maintained, it can last centuries. But it does have enemies: water, fungus, and insects can dramatically shorten the life of wood.

Wood is used in many forms on the exterior of buildings in Gettysburg — in clapboards, shingles, ornament and trim; and these elements contribute significantly to the building's character. They also protect the frame of the structure from the weather, which extends the life of the building. Consequently, these elements should be protected so that they may continue to contribute to the beauty and integrity of the building for generations to come.

One of the most common projects encountered in historic building rehabilitation in Gettysburg is the maintenance and repair of wooden siding. Options for dealing with these projects are outlined on the following pages.

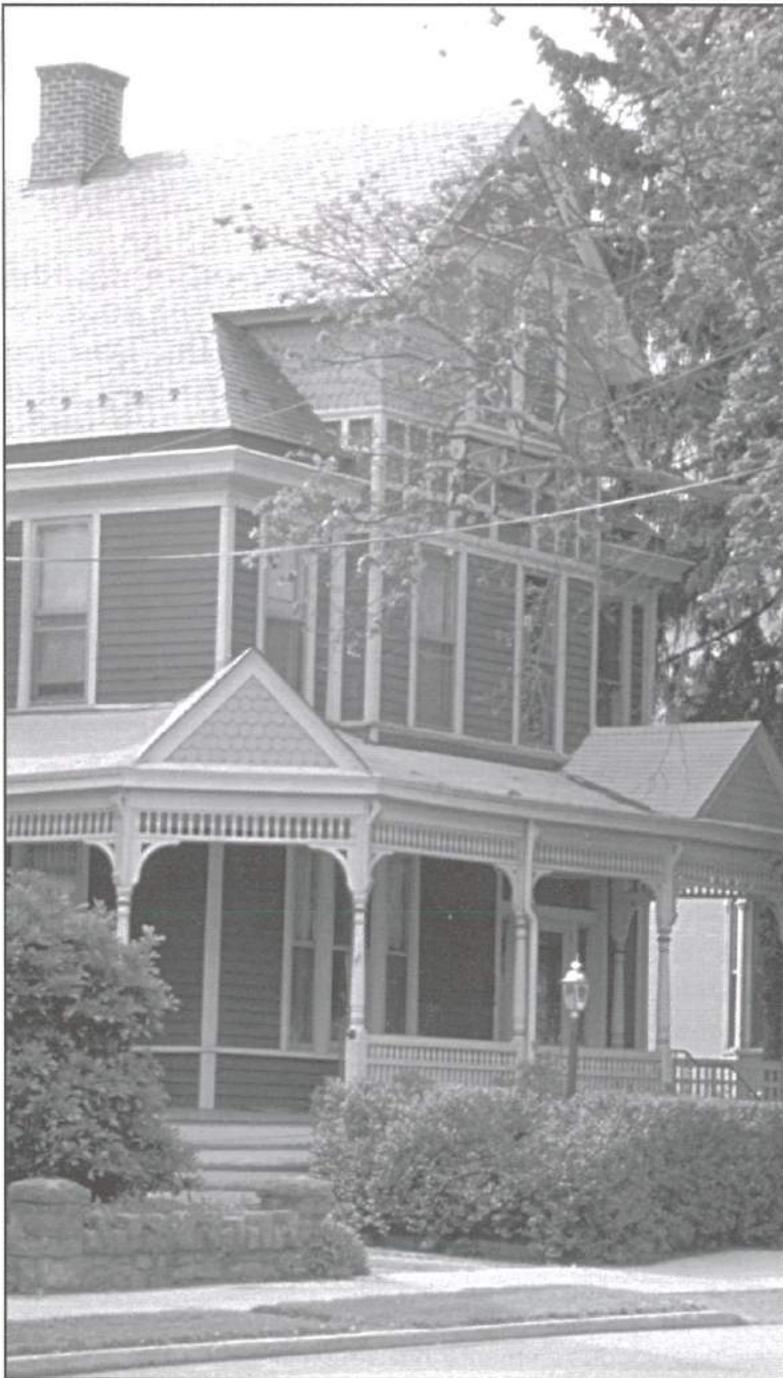

The house at 204 Carlisle Street features wood in a variety of sidings, facings and ornament.

# WOODEN WALLS

## Types of Wood Siding

In Gettysburg the most common types of wood siding are drop siding and clapboards.

Drop siding, also called German siding (pictured at the right), is composed of interlocking horizontal panels. Each panel has a flat surface with a rounded channel at the top.

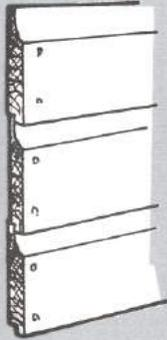

Clapboard (pictured at the right), also called bevel siding, lap siding, and weatherboard, is composed of single boards, tapered from the top to the bottom, and nailed in overlapping fashion. Boards are typically about 4" wide and the overlap produces a distinctive shadow effect that has not been successfully reproduced by artificial siding.

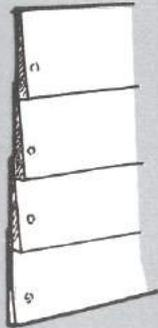

Wood clapboards at 139 Carlisle Street.

## TREATING WOOD DETERIORATION

Water infiltration, poor maintenance, and the lack or improper use of paint can lead to decaying wood and loose, cracked, and missing siding and other wooden elements. The options listed below pertain to all wood siding, shingles, ornament and trim.

### OPTIONS

- 1 FIRST CHOICE:** Repair damaged wooden siding by reinforcing, patching, or piecing. Repair simple cracks and splits with strong exterior wood glue. Warping may be repaired by careful, slow, and well placed nailing or drilling.
- 2 SECOND CHOICE:** Repair the pieces of wood that can be repaired; replace the pieces that are too deteriorated for repair with new wood of the same size, profile, and character as that of the historic wood. Putty or wood filler should be used to smooth out the seams between old and new wood.
- 3 THIRD CHOICE:** When deterioration is too severe or extensive, replace all deteriorated wood with new wood of the same size, profile, and character as that of the historic wood. Take a sample of your siding or other wooden element to the lumber yard to get a close match.

**NOTE:** Occasionally, the installation of new wooden siding is not feasible. In such special instances, a compatible artificial siding that conveys the same visual appearance as the historic siding should be chosen. See the appendix on Guidelines for Artificial Siding for more information on this subject.

### PRIORITIES FOR WOOD IN GETTYSBURG:

- Retain, to the greatest extent possible, remaining wood clapboards, wood shingles, and other historic wood materials.
- Maintain wooden exterior elements with hand scraping, hand sanding, and repainting.
- Conduct regular inspections on wooden exterior elements.
- Paint wooden elements that were historically painted. Don't leave these surfaces unpainted; don't treat with a "natural" finish. Treated wood should be painted following the required period of weathering.



## DEALING WITH ROTTEN WOOD

Most wood deterioration is caused by fungi that thrive if given enough water and suitable temperatures. The prevention of wood decay begins with the elimination of excessive moisture and the use of wood preservatives that act to poison the "food" needed by the fungi to survive.

### THE ICE PICK TEST

To determine if your wood really is rotten, perform this test:

1. With gentle hand pressure, push an ice pick into the surface of the wood that you think may be rotted. If easy hand pressure pushes the pick into the wood to a depth of about  $\frac{1}{2}$  inch, your wood **may** be rotten.
2. Lift a small section of the wood with the tip of the ice pick. If the wood has rotted, it will lift in small sections across the grain. Healthy wood will typically lift in long splinters.

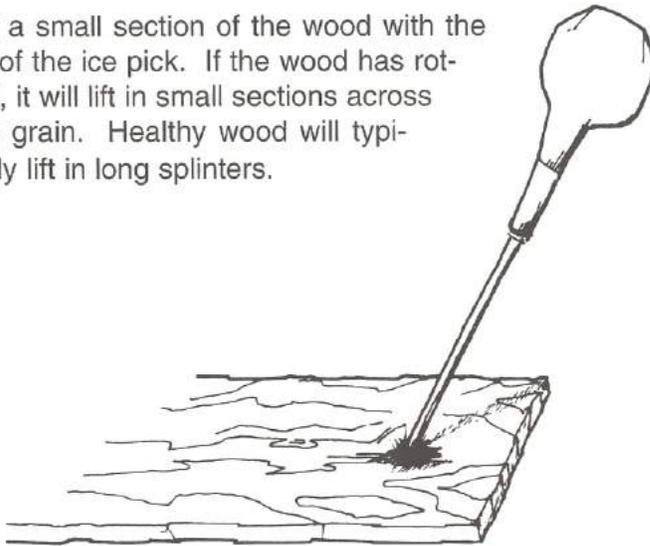

### NEVER

Never paint or otherwise cover a deteriorated wooden surface without repairing the source of the deterioration.

### FOR MORE INFORMATION SEE

- Building Maintenance/  
Water & Your Building
- Exterior Color and Paint

## WOODEN WALLS

### Types of Wood Rot

**Soft Rot** is a slow decay that appears as a cracked surface and is caused by extended saturation or alternating wet-dry cycles.

**Brown Rot** is a serious form of rot resulting from excess moisture and fast-moving inner deterioration of the wood. The result is a crumbly surface that turns wood a brown color. Cracks are visible across the grain of the wood, and they permit greater amounts of water to penetrate, which results in greater deterioration.

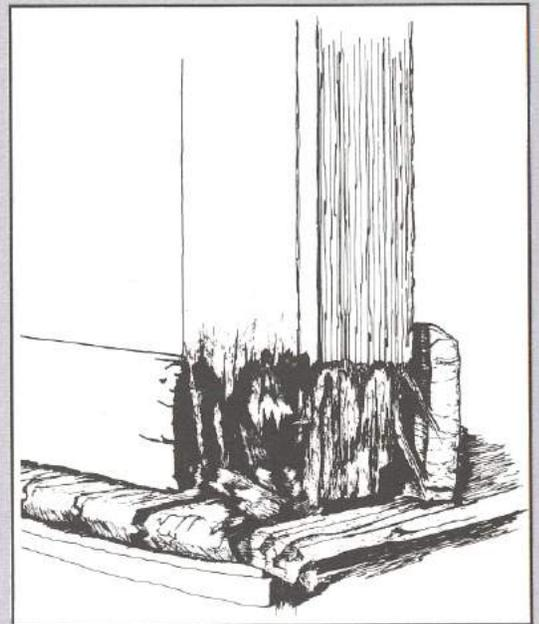

**Dry Rot** is the most serious type of rot. It is a fungal infestation caused by excessive moisture. Infested wood crumbles to the touch and is easily and deeply penetrated by a penknife. This rot conducts water deep into the wood, and may leave white strands or tendrils that eventually form into sheets.

# ARTIFICIAL COVERING OF WOODEN WALLS

## A Siding Quiz

### True or False?

Artificial siding is maintenance free.

### False.

- Artificial siding can cause and increase maintenance problems by hiding structural defects, water damage, and insect damage, and by allowing such damage to progress unnoticed.
- Aluminum siding is easily dented; its painted surface is easily scratched. Panels can fade in the sun, and need to be painted with special products to renew their appearance.
- Vinyl siding is prone to cracking in cold weather, and it is difficult to match replacement pieces for both aluminum and vinyl.
- Although much vinyl siding comes with a lifetime warranty, because it is a relatively new building material, it is difficult to predict how long it will really last. Other vinyl products, such as windows, appear to have life spans that are considerably shorter than expected.
- In recent years, many homeowners have turned to painting their aluminum and vinyl siding, becoming tired of the color, or realizing that these materials were really not "maintenance free." Once painted, the artificial siding will need to be painted as often as wood.

## ARTIFICIAL SIDING

Mass-produced siding was intended to imitate traditional building materials; but the imitation is rarely convincing. Aluminum and vinyl siding are extruded pieces of metal and plastic, respectively, and are much thinner and lighter in weight than their wood counterparts.

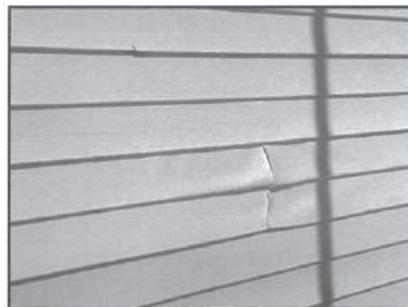

Vinyl siding is susceptible to bending and denting. Its method of attachment leaves unsightly joints. Both of these conditions give vinyl siding an appearance that is uncharacteristic of wood siding.

***It is the policy of the Gettysburg HARB that highly visible walls of buildings in the historic district should remain covered with wood siding.***

### Why Not to Use Artificial Siding on Your Historic House

**DESTROYS APPEARANCE:** The installation of synthetic siding often results in the visual and physical loss of significant historic building material and distinctive detailing that defines and characterizes a home. This diminishes the historic character of your building.

**INCREASES DETERIORATION:** Covering the original siding can lead to rot (from moisture infiltration) and deterioration (from fasteners), and the installation of new siding makes monitoring the condition of your house difficult.

**REDUCES VALUE:** By removing the unique detail and character of your home and covering it with a mass-produced product, your house looks mundane — more like all the others. It loses its distinctive qualities that can mean a higher value in the marketplace. Also, many potential home buyers buy historic houses specifically for their special character — a character that is destroyed by installing artificial siding.

### When NOT to Use Artificial Siding

- Over brick, stone, or other masonry
- Over unusual examples of historic siding
- When wood siding is still functional
- When paint on wood siding has failed simply due to poor preparation, incompatible paints, or lack of maintenance
- To achieve a "maintenance-free" house

## POTENTIAL PROBLEMS WITH CONCEALING WOOD SIDING

Concealing wood siding with other materials can lead to a variety of problems. One of the worst problems occurs when artificial siding reduces the ability of your building to “breathe.” Artificial sidings create a sealed barrier between the original siding and the new siding. In the cold weather, moist air from inside the house tries to escape to the exterior. When it reaches the synthetic siding, it cannot escape, and so it remains, resulting in the deterioration of the wood siding and underlying structural elements. Moisture penetrating the historic siding from other sources results in the same type of deterioration.

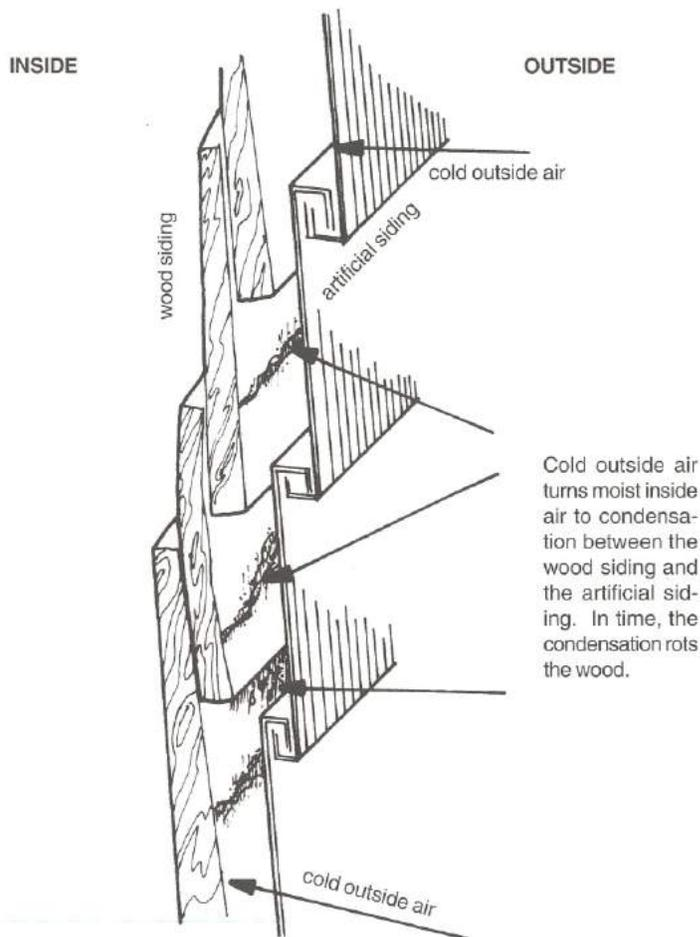

### ALSO:

- Curved areas cannot be duplicated in artificial siding.
- Improper installation of artificial siding is the major cause of problems.
- It is difficult to change the color of your house once artificial siding has been installed.

## ARTIFICIAL COVERING OF WOODEN WALLS

### New Siding and Old Windows & Doors

Many historic windows and doors have significant frames, molding, and trim (1). A typical problem with artificial siding on historic buildings is the damage, removal, or covering of these elements. Some installers cut down these elements, which permanently damages them (2). Some install vinyl channels at the edges of the frame. Others remove the elements, which gives the building a barren, characterless look. Still others wrap the elements in vinyl or aluminum, which hides the historic features and increases deterioration.

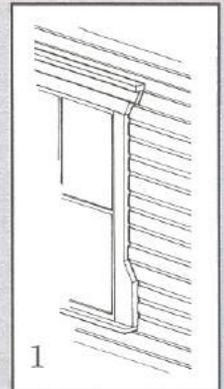

The addition of artificial siding over existing materials results in a greater wall thickness, which gives frames and trim the appearance of being set *back* from the wall, rather than projecting *from* it (3). This is a significant visual change that diminishes the character of the building.

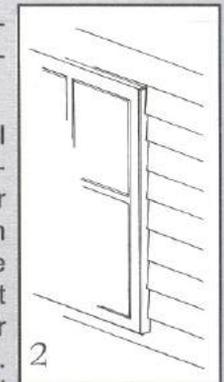

To avoid these problems, be sure your contractor will retain windows, doors, and all related elements. Don't allow them to be cut down or covered. Older materials may need to be removed to maintain the appropriate depth, or spacers may need to be installed, which will require meticulous work by experienced professionals. If trim elements must be removed due to deterioration, replace them with new elements of the same material and detailing.

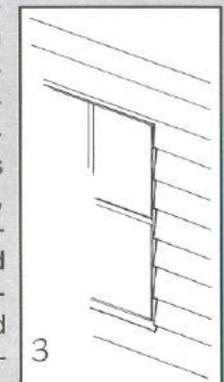

# ARTIFICIAL COVERING OF WOODEN WALLS

## Replacement Materials

Over the years, a wide variety of materials has been used by property owners to cover wood siding in an attempt to gain relief from maintenance and repair. The pictures below illustrate how this practice significantly changes the appearance of historic resources, and show that such materials are generally not maintenance-free.



## POTENTIAL PROBLEMS WITH VINYL AND ALUMINUM SIDING

Vinyl and aluminum siding, like other substitute materials, have characteristics that easily identify them as substitutes, and qualities that are not usually advertised by the manufacturer or installer.

This artificial siding is dented and warped. Its uneven surface and obvious joints diminish the historic character of the building.



This metal siding was torn apart and large pieces were subsequently removed. Parts of the damaged substitute siding remain, detracting from the appearance of the house, and the historic wood siding is left open to the weather.



The simulated wood graining of this vinyl siding in Gettysburg does not make it a convincing substitute for wood siding.



### TRY THIS: Consider Removing Your Artificial Siding and Restoring Your Wood Clapboards.

- This will allow your building to function as originally designed and will expose problems that may have developed since the artificial siding was installed.
- Expect to replace about 20% of the wood clapboards.
- Expect surprises. Trim and detailing may have been removed.
- Aluminum siding can be sold for recycling.

# MASONRY WALLS



The Sheads & Buehler Building formerly at 101 Carlisle Street, built in 1859 (razed ca. 1965). Photo courtesy of the Adams County Historical Society.



## EXTERIOR WALLS of MASONRY

Brick is the most common type of masonry in Gettysburg. Stone has also been used, and it is primarily found in foundations. The color and texture of individual bricks and stones, the pattern in which the units are laid, and the consistency, color, size, and shape of the mortar joints between the units all give character to masonry in the Borough. Masonry is also used ornamentally on buildings in Gettysburg. Ornament and detailing in masonry contribute greatly to the character of a building.

Although masonry is typically viewed as a very strong building material, excess water can literally turn it to dust. Other major causes of masonry deterioration include general neglect, improper maintenance, inappropriate repair, and harsh cleaning methods.

The most common problems with masonry in Gettysburg include the crumbling and flaking of individual bricks and the loss or loosening of individual bricks. This type of deterioration is typically caused by excess moisture penetrating the masonry wall — a problem that has been made worse because many buildings were sandblasted 20 to 30 years ago. This removed the protective coating on the brick, exposing the softer interior and leading to more rapid deterioration.



The Old Sewing Factory on North Fourth Street,  
a brick structure on a stone foundation.

# MASONRY WALLS

## Crumbling and Flaking Masonry

If the following conditions exist, identify and fix the source of the problem, then replace your bricks or stones.

**Spalling** can have two effects on masonry, both caused by excess moisture. First, water with its dissolved impurities is absorbed into a wall, and collects *inside* individual bricks and stones, or *behind* them. When caught *inside*, the impurities crystallize, then create pressure that causes the outside layer of the masonry to fall off (1).

When water collects *behind* the bricks or stones, freezing and thawing of the wall causes them to contract and expand. They actually move, and this can break the bond between the unit and the surrounding mortar. When this happens, individual bricks or stones actually separate from the wall (2).

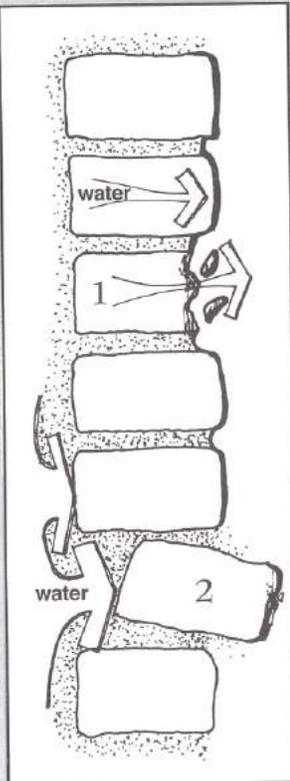

**Dusting** is a condition that occurs after the surface of the masonry has fallen off, and the softer, inner core of the masonry is being rubbed away. Dusting occurs after sandblasting or extensive spalling, or because of the use of soft bricks that were never intended for the exterior of a building.

## MASONRY DETERIORATION: What to do about loose or missing masonry units.

### ALWAYS

Remedy the cause of excess moisture in the wall before proceeding with repair or replacement of individual masonry units. See the information on spalling and dusting in the sidebar on this page.



A crumbling brick wall in Gettysburg.

### OPTIONS

- 1 1ST CHOICE:** If original masonry units that have become loose are sound, repair the damaged wall by securing the loose units and reattaching the separated units. (See the information on mortar later in this chapter.)
- 2 2ND CHOICE:** Use as much original material as possible to repair the damaged wall. For units that cannot be re-used, replace with new units of the same material, color, size and texture, using the same bonding pattern.
- 3 3RD CHOICE:** For significant stonework, consider hiring a professional experienced in the repair of historic masonry to pursue mechanical repair or composite patching.

### CONSIDER

- Consider using recycled brick, but use only hard brick intended for the exterior of a building, ensuring that the face of the brick intended for the exterior will face the outside.
- If work is also being done in a less visible area of the building, consider relocating masonry from the less visible area to the more prominent area.

### NEVER

- Avoid removing masonry units without installing replacements.
- Avoid installing replacements that don't match the original in size, shape, color, profile, and bond.



## HOW TO CLEAN MASONRY

Masonry walls can become dirty or stained for many reasons. Metals or industrial products, moisture-related problems, and unwanted paint commonly affect brick and stone walls. Dirt accumulates on buildings over time, and dirty areas remain wet longer, which invites deterioration. Cleaning can improve a building by restoring the crispness to detail and by reducing the amount of moisture absorbed into the building materials. But, the normal aging and weathering of a building can form a natural coating on the building surface. **This coating need not be removed if it is not contributing to, or concealing, deterioration.**

### STEPS TO CLEANING A BUILDING

1. Determine if the building really needs to be cleaned. See below.
2. Identify the type of masonry, the source and type of the stain, and the possible cleaning methods. (See the Masonry Cleaning Methods Table on the next 2 pages.)
3. Determine and evaluate the effect of each possible method on the masonry by conducting test patches. Water cleaning methods are the safest, cheapest, and simplest methods for cleaning masonry.
4. Prepare the masonry surface. Complete all necessary repointing **before** cleaning to discourage excessive water infiltration. (Cleaning may disturb some mortar, requiring additional repointing after cleaning. See the information on mortar on the last three pages of this chapter.)
5. For all methods, perform test patches to determine the effects of the method over time. Be aware that some effects may not be visible until several months have passed and all weathering possibilities have occurred.
6. Proceed with the gentlest cleaning method. If the desired cleanliness cannot be achieved, test the next strongest option that provides the desired result without damaging the masonry.

### DOES YOUR BUILDING NEED TO BE CLEANED?

These Conditions Mean That Your Building **May** Need to Be Cleaned:

- Graffiti marks your building.
- Significant detailing is obscured by heavy soiling.
- A spotty white haze appears in a horizontal pattern on the brick. (This may be efflorescence.)
- Biological growth is present.
- Heavy soiling is contributing to the deterioration and decay of the building.

## MASONRY WALLS

### Clean Part or All of the Building?

Although each stain should be treated individually, and although cleaning an entire building just to clean it is not recommended, be aware that spot cleaning of stains may result in a wall that looks spotty.



### GUIDELINES FOR CLEANING:

1. Clean only to halt deterioration or remove heavy soiling.
2. Aim to reduce water infiltration into the building.
3. Treat stains individually.
4. **NEVER** proceed with a wet cleaning operation in cold weather. Chemicals will work differently, and frost can severely damage a thoroughly wet building.

For more information see these sections in this guide:

- Water and Your Building in the Maintenance Chapter
- Exterior Color and Paint

# MASONRY WALLS

## The Dangers of Abrasive Cleaning

Abrasive cleaning methods, tools, and equipment are **never** an option for cleaning historic buildings. This includes all:

- Sandblasting
- Wire and metal brushes
- Rotary wheels
- Power sanding disks
- Belt sanders
- Similar tools

These methods are very difficult to control and typically do irreversible damage to historic building materials.

Abrasive cleaning methods:

- Remove the outer surface of the masonry
- Damage detailing
- Allow increased water penetration and increased deterioration

If your building was previously cleaned by an abrasive method, it may require painting for protection. Call the Historic Preservation Officer for more information at 334-1160.



The rough, pock-marked surface of this brick in Gettysburg is a sign that it has been sandblasted.

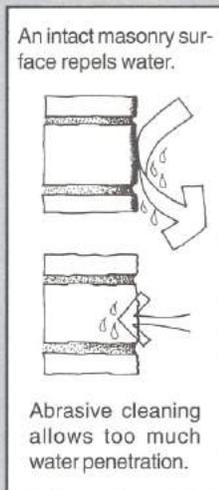

## MASONRY CLEANING METHODS

*Always begin with the gentlest cleaning method available.*

### 1st CHOICE METHODS: WATER WASHING

Water washing is the gentlest, easiest, most economical cleaning method. Begin with option #1. If the desired cleanliness cannot be achieved, move to option #2, then option #3, then #4, as necessary.

#### Option 1: Hand Scrubbing

For Which Stains	For Which Materials	Watch for these Hazards	Consider This
Dirt, grime, metallic stains, biological growth & related stains, soot, efflorescence.	Calcium-based masonry, like limestone, marble, and brick	Be careful not to use too much water. Excess water increases the drying time required and can lead to deterioration.	Use a garden hose, a bucket, possibly a non-ionic detergent (like dishwashing liquid), and a bristle (never metal) brush.

#### Option 2: Spraying

For Which Stains	For Which Materials	Watch for these Hazards	Consider This
Heavy dirt & grime, soot, metallic stains, biological growth & related stains, efflorescence.	Brick and calcium-based masonry, including limestone and marble.	Be careful not to use too much water. Excess water increases the drying time required and can lead to deterioration.	Involves the use of a hose with regular pressure applying a fine mist of water to the masonry surface for a number of hours. May be combined with hand scrubbing.

#### Option 3: Low Pressure Washing

For Which Stains	For Which Materials	Watch for these Hazards	Consider This
Heavy dirt & grime, soot, metallic stains, biological growth & related stains, efflorescence.	Brick and calcium-based masonry, including limestone and marble.	High pressure can damage brick, so perform test patches. Start with very low pressure, increase gradually until reaching desired cleanliness.	Involves the use of a low-pressure mechanical water jet with less than 500 psi. Can be combined with chemicals.

#### Option 4: Steaming

For Which Stains	For Which Materials	Watch for these Hazards	Consider This
Heavy dirt & grime, soot, metallic stains, biological growth & related stains, efflorescence.	Brick and calcium-based masonry, including limestone and marble.	See notes on chemicals on the next page.	Involves steam generated at the masonry surface at low pressure, possibly in combination w/ detergents or chemicals.

# MASONRY CLEANING METHODS

## 2nd CHOICE METHODS: CHEMICAL CLEANING

If water washing cannot produce the desired result, proceed with Chemical Washing under the guidance of an experienced professional. Choose chemicals based on the nature of the building materials and the nature of the stain. Use the weakest possible solution and neutralize afterwards. Be sure to follow manufacturer's directions, particularly regarding the range of appropriate temperatures for working with chemicals, and the potential hazards.

### Option 5a: Alkaline Chemicals

For Which Stains	For Which Materials	Watch for these Hazards	Consider This
Paint, metallic stains	Masonry that is sensitive to acids, like limestone, marble, calcium-based sandstone, polished granite, glazed brick and terra cotta.	Chemicals are potentially dangerous to people, the environment, and the building if not used cautiously.	Consult a professional experienced with historic buildings before beginning a chemical cleaning project.

### Option 5b: Acidic Chemicals

For Which Stains	For Which Materials	Watch for these Hazards	Consider This
Paint, metallic stains	These chemicals are typically used on slate, granite, unglazed bricks, concrete, and other non-calcium based stones.	Chemicals are potentially dangerous to people, the environment, and the building if not used cautiously.	Consult a professional experienced with historic buildings before beginning a chemical cleaning project.

### Option 5c: Poultices

For Which Stains	For Which Materials	Watch for these Hazards	Consider This
Industrial products, graffiti, metallic stains	Poultices can be created for most types of building materials.	Chemicals are potentially dangerous to people, the environment, and the building if not used cautiously.	Consult a professional experienced with historic buildings before beginning a chemical cleaning project.

# MASONRY WALLS

## Other Damaging Conditions for Masonry

**Efflorescence:** Efflorescence is a spotty, white haze appearing in a horizontal pattern in brick. It is created by salts that are deposited after water evaporates inside the wall, and means there is excess moisture present. The moisture enters through a defect, or by rising damp, and then evaporates at the interior or exterior.

**Rising Damp:** Rising damp is the condition that exists when suction pulls groundwater into a masonry wall from the bottom up. Rising damp can result in spalling, efflorescence, and other deterioration.

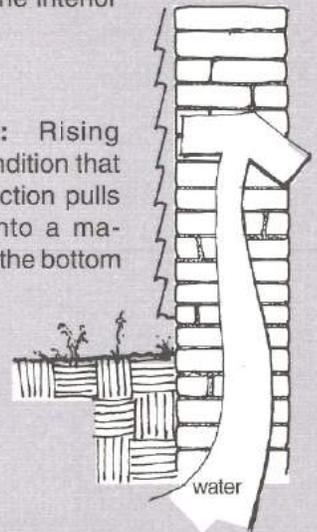

**Biological Growth:** Mold, algae, fungus, and vegetation can grow on a masonry wall when excess moisture is present. The moisture may be a result of faulty caulking or mortar; cracks created by building settlement; faulty gutters, downspouts, and flashing; improperly ventilated interior spaces; or excessive shade. This growth encourages moisture to remain in the masonry, thus making it more susceptible to deterioration.

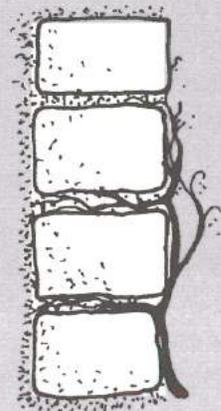

# MASONRY WALLS

## Priorities for Masonry in Gettysburg:

- Always determine the appropriate mortar formula for historic masonry. Always test the existing mortar to determine its composition, then base the new mortar composition on the old.
- Keep historically painted masonry surfaces painted; avoid painting surfaces that weren't painted historically.
- Avoid using abrasive methods to clean masonry surfaces.



**JOINT PROFILES:**

- 1 Flush
- 2 Struck
- 3 Concave
- 4 Weathered
- 5 Raked

**DO THIS:** Check the credentials of any contractor you may consider for working on the masonry and mortar of your historic building. Choose a contractor who is experienced in properly repointing historic masonry walls. **If your contractor insists on widening the mortar joints, choose someone else.**

## MORTAR

Mortar is composed of sand, water, and lime or Portland cement. Historic mortar may also contain ash, horse hair, oyster shells, or other additives. The process of using mortar to bond masonry units — brick or stone — to form a wall is called **POINTING**. **REPOINTING** is the process of removing deteriorated mortar and applying new mortar to restore the strength and appearance of the wall.

**WHAT YOU SEE:** Crumbling, loose, and/or missing mortar.

**THE PROBLEM:** Building movement, extreme weathering, or excess moisture.

### OPTIONS:

- 1 1ST CHOICE:** If the pointing is firm, intact, and not eroded more than 1/3 inch, do not repoint. Inspect the mortar and the entire building regularly for further deterioration.
- 2 2ND CHOICE:** If the joints have eroded more than 1/3 inch; or if mortar has fallen out; or if cracks have formed in the mortar; or if mortar has separated from the masonry units; or if mortar sits loosely in the joint; proceed with repointing only the damaged area, following the guidelines in this manual.
- 3 3RD CHOICE:** If you think the entire wall needs repointing, seek professional assistance.

**ALWAYS**

- Repair the cause of the problem before treating the symptoms. If building movement is ongoing, contact a professional engineer.
- Seek professional assistance for determining appropriate mortar consistency.

**NEVER**

- Never use a synthetic caulking compound.
- Never use a mortar mixture with a Portland cement content higher than 20% of the total volume of lime and cement combined.
- Never use a mortar that is harder than the surrounding masonry.

## GUIDELINES FOR REPOINTING

1. New mortar must match the strength of the historic mortar, and must be softer than the surrounding masonry.
2. Mortar to be used for repointing should match the original mortar in color, texture, and composition.
3. Sand color is critical to determining mortar color.
4. Although it will be time and labor intensive, use only hand tools for removing old mortar. Using power tools will damage the edges of the stone or brick. Remove mortar to a depth of 3/4 inch or deeper to reach sound mortar.
5. When flushing the joints after removing mortar, use as little water as possible in a gentle stream.
6. Copy the tooling method and detailing of the historic joints. Be aware that these details may change on different portions of the building. Check for joint profile on protected areas of the building, like under eaves, because weathering may alter the profile.
7. Avoid removing sound mortar to achieve a uniform appearance. Achieve a uniform appearance by properly analyzing the existing mortar and matching it to the original recipe in only the damaged area. New mortar of the historic recipe should weather to the color of the original.

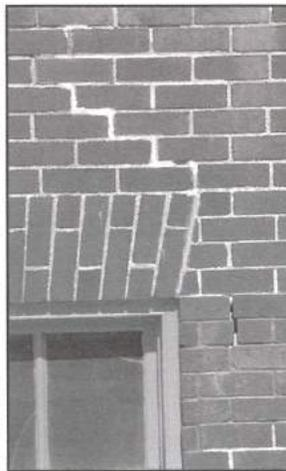

A variety of mortar joints. Note the missing mortar and the poorly repointed joints that are too wide.

### WHY FUSS OVER LIME OR PORTLAND CEMENT?



- Lime mortar and Portland cement mortar are significantly different.
- Although it may at first seem that a harder mortar is better, this is rarely true for historic brick. Bricks made today are considerably harder than the bricks used in Gettysburg's older buildings. Although the hardness of Portland cement mortars work well with today's modern bricks, they will destroy Gettysburg's older masonry in a relatively short period of time.
- Lime mortar is relatively soft and porous. Portland cement mortar is hard and nonporous.
- Lime mortar is softer than the surrounding historic brick, which allows the brick to expand and contract as it should. Hot bricks expand, forcing the mortar joint to contract. Cold bricks contract, requiring the mortar to expand.
- In masonry walls with joints of lime mortar, water can drain and escape through the mortar joints. In masonry walls with joints of Portland cement mortar, water stays in the brick or in the old lime mortar that lies behind the new Portland cement mortar. This causes the brick to expand. Because the Portland cement is too strong to move, the brick moves instead, resulting in the cracking, spalling, dusting, and loss of the brick, as well as the deterioration of the remaining lime mortar.

## MASONRY WALLS

### Is There Lime or Portland Cement in Your Mortar?

Remove a loose piece of mortar from an inconspicuous location. Soak the mortar in water. If it softens and crumbles under pressure, it has a lime base. If it softens but won't crack, it has Portland cement. Keep in mind that your building may have been repointed a number of times, and possibly with the wrong type of mortar, so you should carefully inspect your building and you may need to collect and test a number of samples.

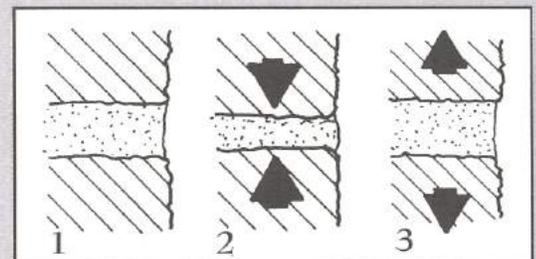

Soft Historic Mortar and Historic Brick (1). The solidity of the wall is maintained throughout contraction (2) and expansion (3).

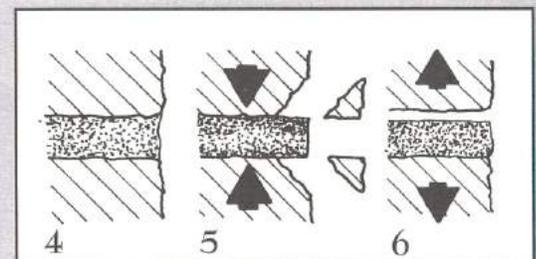

Hard Modern Mortar and Historic Brick (4). The forces of contraction (5) and expansion (6) break the bond between the bricks and the mortar and the wall deteriorates.

# MASONRY WALLS

## Historic Mortar Recipes

The following recipe is a starting point for a mortar suitable to historic masonry.

1 part hydrated lime  
+  
2 parts by volume sand of historic color  
+  
enough water for a workable mix

This recipe can be modified with some white Portland cement to improve workability and drying, but Portland content should never exceed 20% of the total volume of lime and cement combined. Portland cement should be white - never gray or light gray. You could begin by testing one of these recipes that include Portland cement:

1 part white Portland cement  
+  
2 or 3 parts hydrated lime  
+  
6 parts sand of historic color

OR

1 part white Portland cement  
+  
4 parts hydrated lime  
+  
10 parts sand of historic color

## WHAT ARE THE EXACT COMPONENTS OF YOUR MORTAR?

A trained professional can determine the exact components of your mortar in a laboratory, but you can conduct a relatively simple experiment yourself. Follow these steps:

- 1 Collect three or four mortar samples from different locations on your building. Don't take the samples from the surface, because surface mortar has weathered and will be darker than the original color. Multiple samples are required because your building may have been repointed several times. Set one sample aside for comparison.
- 2 Keeping each sample separate, break the samples apart with a wooden mallet or dissolve them in muriatic acid (available from masonry suppliers).
- 3 When the sample has completely broken down, remove it from the liquid, wash the remaining components in water, and allow the sample to dry. Blow away any powdery material, which is lime or cement.
- 4 Inspect the remaining material with a magnifying glass to determine the size and color of the components of the mortar. For your new mortar, be sure to choose sand that matches the color of the sand in your sample. *Sand color is critical to determining final mortar color.* Sands of different colors are available from masonry suppliers. Use a pigment to obtain the correct color as a last resort.
- 5 Other materials in your sample — like shells, hair, or ash — may be harder to obtain. Consult your masonry supplier or Gettysburg's Historic Preservation Officer for suggestions.
- 6 Once you have assembled the appropriate components, try varying recipes (see information in the sidebar at the left). Allow them to dry in an oven, and then compare them to the historic sample you set aside in Step 1.

# WINDOWS AND DOORS



The building at 22-22½ Chambersburg Street in 1902, prior to renovations.  
Photo courtesy of the Adams County Historical Society.





# WINDOWS AND DOORS

## The Significance of Windows and Doors in Gettysburg

Windows and doors are among the most prominent features of buildings in Gettysburg.

Windows typically comprise about 20 to 30 percent of a historic building's surface area, and they act as both interior and exterior elements. Historic doors often used size and detailing to draw attention to the entrance.

Significant parts of doors and windows include their materials and shape, panel and pane arrangement, moldings, hoods, fanlights, and sidelights.

Windows and doors receive consistently hard use, but they are so thoroughly integrated into the structure of a house that complete replacement is rarely advisable. Repair and weatherization are often more practical and economical than most property owners realize.



A historic window at 48 North Washington Street.

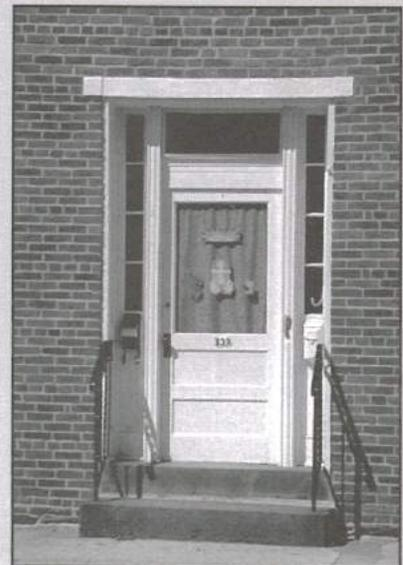

A historic doorway at 137 West Middle Street.

# WINDOWS AND DOORS

Windows and doors are significant and should be retained if they:

1. Are original.
2. Reflect the original design intent for the building.
3. Reflect period or regional styles or building practices.
4. Reflect changes to the building from major events.
5. Are examples of exceptional craftsmanship or design.



An oriel window in the 100 block of Carlisle Street.

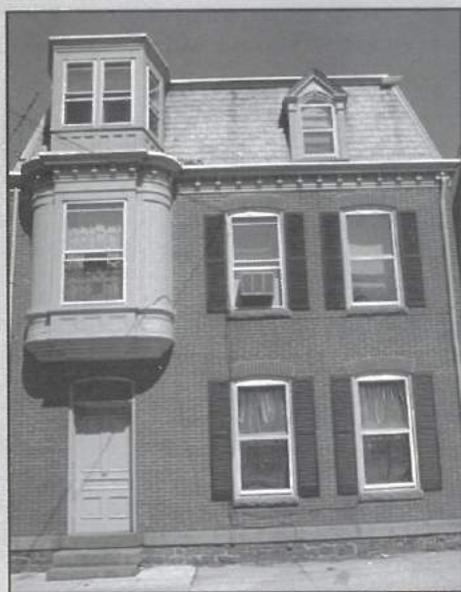

Many buildings in Gettysburg feature oriel windows (bay windows above the first floor) such as this house at 47 West Middle Street. Because of their detailing and craftsmanship, these windows are significant.

## PARTS OF WINDOWS AND DOORS

Windows are typically composed of sash in a frame with surrounding trim.

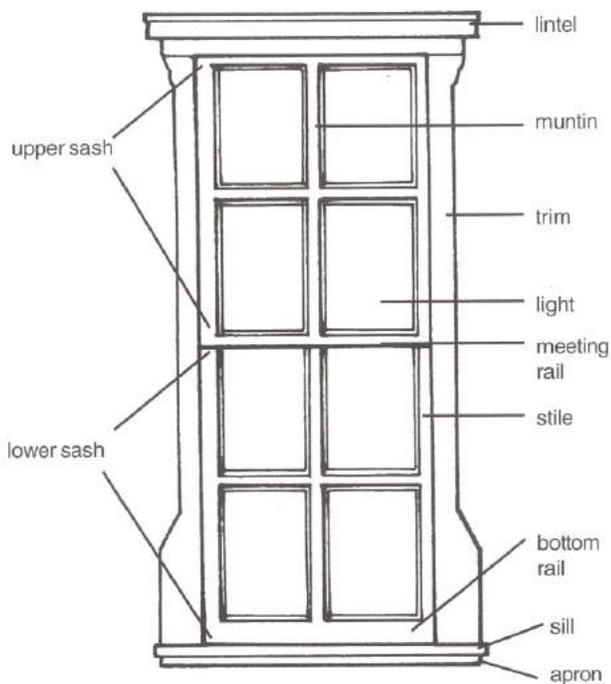

The window at 48 North Washington Street.

Doors are typically composed of panels and rails that are placed in frames. Doors are often combined with transoms and sidelights to create a more elaborate doorway.

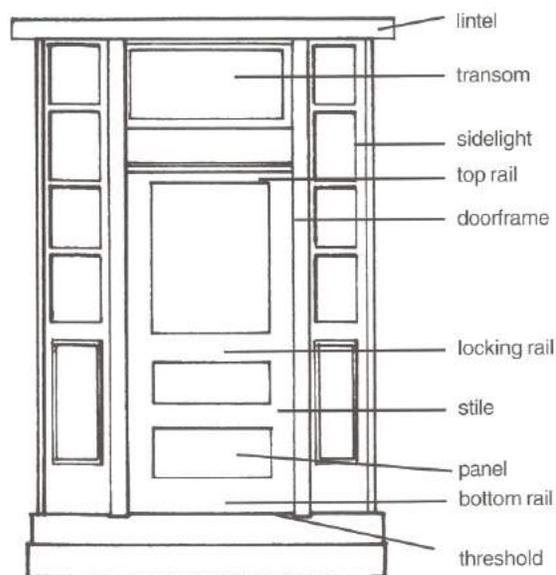

The doorway at 137 West Middle Street.

# SHUTTERS

Shutters were used historically for insulation. They closed over window and door openings to keep the wind and sun out. Shutters are rarely used for this purpose today, but on a historic building they should still appear functional.

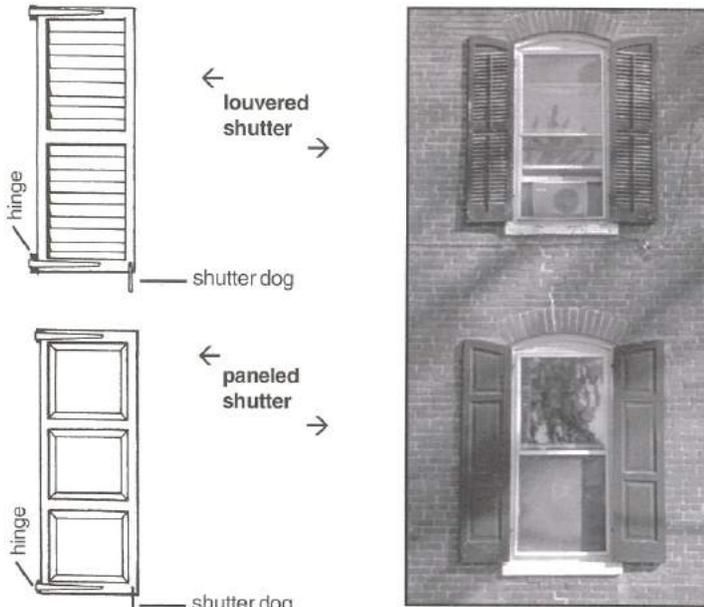

Louvered and paneled shutters at 341 Baltimore Street.

## When are Shutters Appropriate?

Shutters were not installed on all buildings, and should only be added to those historic buildings that did have them. Shutters were used on most Federal style buildings, and were less frequently used on Greek Revival, Italianate, and Queen Anne buildings. (See the history at the beginning of this guide for more information on these styles.) Look for holes near the top and bottom of your window frames, or faded silhouettes of shutters on your exterior walls, or shutter anchors on the wall near your windows. If this evidence exists, shutters may be appropriate for your building.

## Shutter Guidelines:

- Shutters should be attached to the face of the window frame with hinges — not to the wall.
- Many buildings in Gettysburg were fitted with paneled shutters at the first story and louvered shutters at the second story. Replacement shutters should duplicate this pattern.
- Retain ornamental anchors.
- Horizontal divisions of shutters should match those of the sash.
- New shutters should be made of wood.
- Shutters should be installed only if they were used historically.

# WINDOWS AND DOORS

## Shutter Guidelines

Shutters are not appropriate for bay windows, most dormers, and most other ornamental windows.

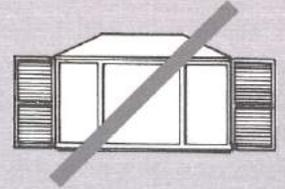

Shutter height should match sash height.

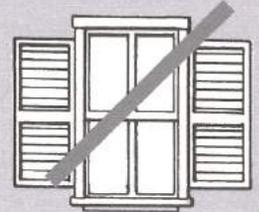

Shutter shape should match window shape.



Shutters should be louvered or paneled.

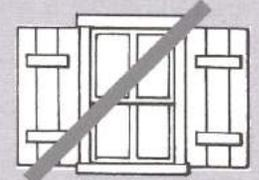

Each shutter should cover 1/2 the entire window opening.

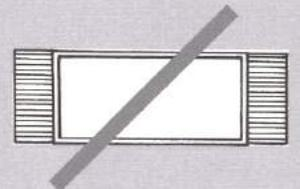

Shutters are not appropriate for bands of adjacent windows.

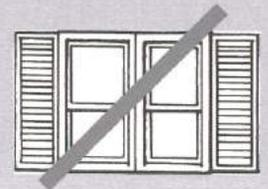

Shutters should lie flat without overlapping when open.

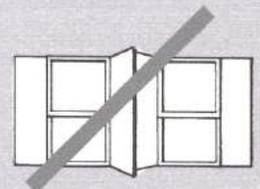

# WINDOWS AND DOORS

## Awnings

In the first half of the 20th century, canvas awnings were often installed on new residences and were added to older residences. Awnings can enhance the appearance of a building and can be up to seven times more effective than drapes in controlling heat gain.

### Guidelines for Awnings:

- The top of the awning should conform to the shape of the window or door opening.
- The awning should be contained within the opening.
- Awnings and their associated hardware should not damage or hide existing historic materials or features.
- Canvas or other flexible, natural materials are preferred. Rigid awnings should not be installed.



Striped awnings on the windows of the Gettysburg Hotel.

**NOTE:** For information on awnings and commercial buildings, see the chapter on commercial buildings later in this manual.

## WINDOW AND DOOR REPAIR IN GETTYSBURG

The options for repairing, rehabilitating, and replacing historic wood windows and doors directly relate to the degree of deterioration present.

### OPTIONS

**1 FIRST CHOICE:** Undertake routine maintenance on windows and doors. This may include replacement of broken panes, repair of sash cords, removal and reapplication of caulking, putty, and weatherstripping, and scraping, sanding, priming, and repainting.

**2 SECOND CHOICE:** Repair decayed parts in place. If wood is badly rotted, treat with fungicide, saturate with linseed oil, fill cracks and holes with putty, consolidate with epoxy or patching compound, sand, prime, and paint.

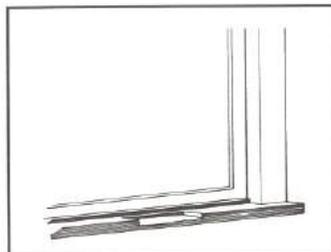

a

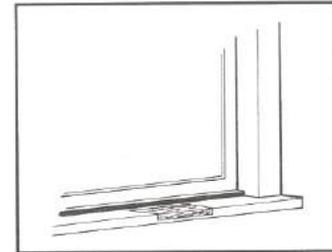

b

**3 THIRD CHOICE:** Without replacing the entire unit, replace parts of the frame and sash or door by patching, splicing, and piecing in (a). Using surviving parts as models, choose replacement parts that match the original in size, shape, material, and all detailing (b). If a majority of a member is deteriorated (c), replace the entire member (d) using the old one as a pattern for the new.



c



d

**4 FOURTH CHOICE:** If a majority of the components of the window sash and frame, or door and door frame, require replacement, consider replacing the entire unit using the guidelines on the next page.

## WHEN TO REPLACE WINDOWS AND DOORS

Wood windows and doors are subject to deterioration from years of use, water accumulation, and insects. But, deteriorated wood windows and doors may look worse than they are. The most commonly affected areas, the sill and the lower rail, often can be restored without replacing the entire unit. In most cases, even if individual units are severely deteriorated, replacement of all the windows and doors in an historic building is seldom necessary and should be avoided. Four out of five times, the verdict to replace an entire window is due only to a rotted sill.

### Signs that a Window or Door Needs Maintenance or Repair

- Loose putty
- Air infiltration
- Stuck sash
- Broken sash cords
- Broken glass
- Peeling paint

*These conditions alone do **not** warrant replacement.*



A deteriorating window sill in Gettysburg.

### Signs that a Window Should be Replaced:

- The existing window cannot be made to fit tightly in the wall because of settlement or deterioration in the outside wall.
- Materials or skills required to repair the window are not available.
- Substantial parts of the window are missing or are so severely damaged that they must be replaced.

#### Caution:

Removing window or door units for repair increases the likelihood of damage. Attempt to repair windows and doors in place.

## WINDOWS AND DOORS

### When are Windows and Doors Deteriorated Beyond Repair?

The ICE PICK TEST can help you determine the extent of deterioration in wood windows and doors.

- If an ice pick inserted into a wood member penetrates the wood less than 1/8 inch, then the wood is solid and the unit does **not** need to be replaced.
- If the ice pick penetrates 1/2 inch or more, the wood **may** have dry rot.

#### What To Do:

- If the condition has affected only a portion of a component, repair the damaged member.
- If the condition has affected a majority of a component, replace the infected member.
- If the condition has affected a majority of the components of the unit, consider replacement of the unit.

*Wood windows and doors can be considered beyond repair when a majority of the component parts require replacement to make the unit weathertight and serviceable.*

A window in need of maintenance in Gettysburg.



# WINDOWS AND DOORS

## Replacement Guidelines

- When a replacement is needed and work is being undertaken in other parts of the building, consider moving a historic window or door from an inconspicuous location to a more visible wall.
- When original windows are missing, replacements should be chosen based on historical, pictorial, or physical documentation. Avoid creating a false historic appearance due to insufficient documentation.
- Check salvage yards, antique stores, demolition companies, and custom manufacture companies for replacements. Be sure to reuse all serviceable historic hardware.
- For multi-pane replacement windows, replacements that have panes of glass divided by muntins (strips of wood) are the best choice. Snap-in muntins, surface applied muntins, and muntins between panes of glass should be avoided. They are not convincing because they don't have enough depth to provide a shadow.
- Picture windows, bay windows, and casement windows should be chosen as replacements only when these types are original to the building.
- Steel-covered hollow core doors have a poor finished appearance and often do not come in sizes and styles that are appropriate for historic buildings.

## CHOOSING REPLACEMENTS

Once it has been determined that a window or door is beyond repair and must be replaced, the type of replacement unit must be chosen.

### OPTIONS

- 1 FIRST CHOICE:** Choose replacement windows and doors that fit the original opening exactly and match the original units in material type, glass color and reflectivity, and:

#### Overall Size

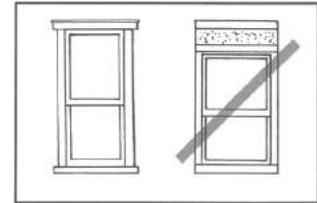
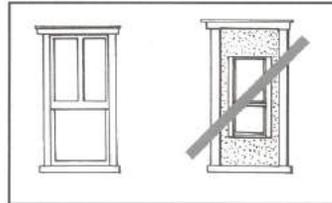

#### Shape

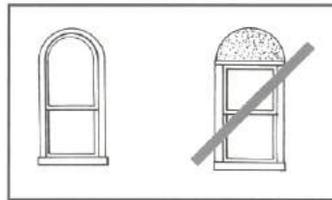

#### Number of panes

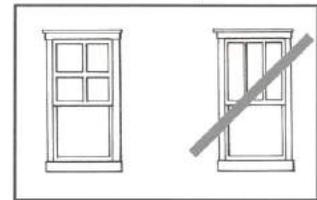

#### Arrangement of panes

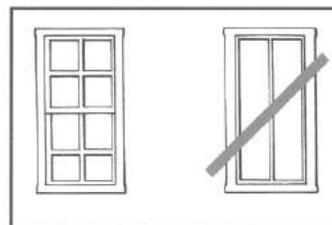

#### Type of operation

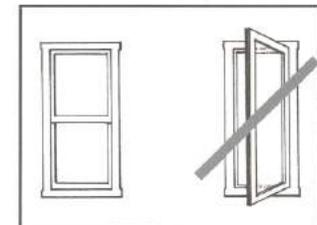

#### Component size (frames, muntins, etc.)

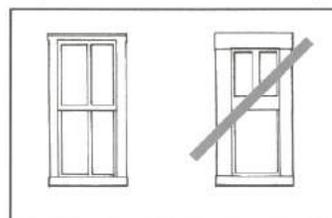

#### Decorative details

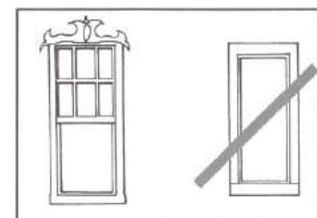

- 2 SECOND CHOICE:** Choose windows and doors of a compatible material that match all the other design details of the original.

## The Size of Window and Door Openings

Maintaining the original size of door and window openings is important because the size contributes to the overall design and visual balance of the building. When replacing historic windows and doors, follow the guidelines below.

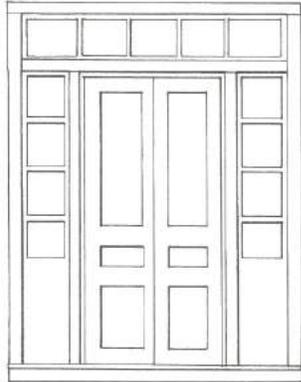

A historic entrance.

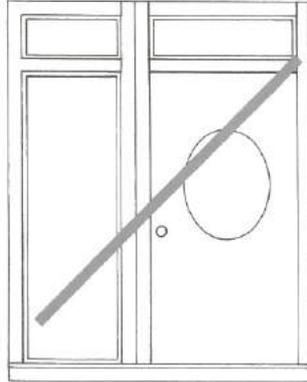

An incompatible modern entrance.



Historic windows with sash that completely fill the opening at 227 Carlisle Street.



An historic window opening reduced in size to accommodate a replacement sash that is too small.

### Guidelines for Window and Door Size:

- Maintain the shape of window and door openings.
- Install window air conditioners on side or rear elevations.
- If a ceiling must be lowered at the interior, provide a setback or slope to allow the full height of the window to remain open.
- Maintain divisions created by sidelights and transoms in entryways.
- Avoid decreasing the size of window or door openings by partially filling them, especially to allow for stock size replacements.
- Avoid enlarging window or door openings to allow for picture windows, bay windows, casements, or other windows not original to the building.

# WINDOWS AND DOORS

## Making New Window and Door Openings

New window and door openings tend to destroy the rhythm and balance of historic buildings and their historic materials. For these reasons, creating a new opening is a last resort alteration, and new openings should never be added to the walls of buildings that are visible from the street.

### OPTIONS

- 1st CHOICE:** Locate the new opening on a wall that is not visible from a public street or alley.
- 2nd CHOICE:** Locate the new opening on a side or rear elevation shielded from public view.



A window converted to a doorway in Gettysburg.

### ALWAYS:

- Create new openings only in locations that will minimize the loss of historic materials and features.
- Create new openings that are compatible in size, scale, shape, proportions, and massing to the wall and the overall building.
- Document the original condition of the building and save removed historic materials for later use.

# WINDOWS AND DOORS

## Filled Window Openings in Gettysburg

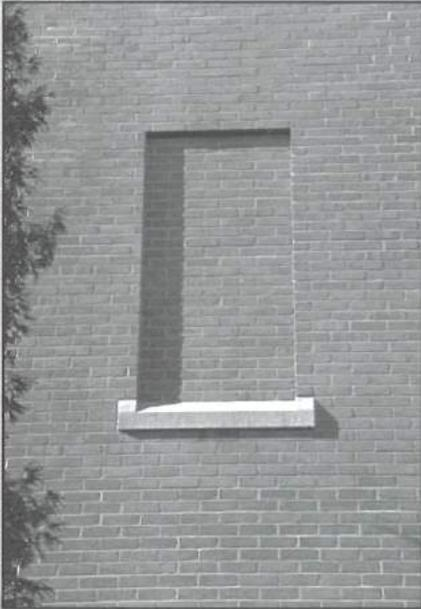

A blank window opening filled  
with brick that matches the wall.



The change in mortar gives away the previous location of  
a window opening on this wall in Gettysburg.

## CLOSING WINDOW AND DOOR OPENINGS

Filling in historic window and door openings destroys the rhythm and balance of a building, and destroys historic materials. This type of alteration is rarely appropriate.

### OPTIONS

- 1 FIRST CHOICE:** Retain the historic window or door in place, with all its associated features. Add materials or treatments at the interior to make the units inaccessible and nonserviceable, while maintaining the external appearance. Painting glass black on the inside or adding other similar materials to achieve the same effect may be considered. Also consider installing shutters over windows and sealing doors.
- 2 SECOND CHOICE:** If window or door units are missing or must be removed due to extensive deterioration, install new units of compatible design, and continue with Option #1.

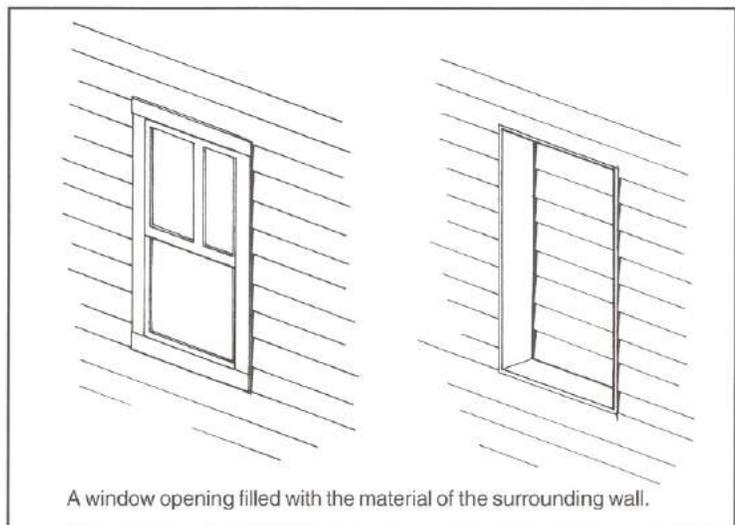

A window opening filled with the material of the surrounding wall.

- 3 THIRD CHOICE:** Fill the opening with a material that is compatible in appearance to the wall facing material. Be sure that the surface of the infill material is recessed from the face of the wall, and the original size and shape of the opening are maintained. Retain as much detailing and ornament in place as possible. Save any removed historic materials for later use.



## INCREASING ENERGY EFFICIENCY IN WINDOWS

Old windows should never be replaced solely for the purpose of improving energy efficiency. An old window that has been properly repaired and provided with a well-fitted storm sash will be as efficient as a new, double-glazed unit.

### OPTIONS

#### 1 **FIRST CHOICE:** Remove and reapply caulking, putty, and weatherstripping.

Tighten the interior lock on the meeting rail of double-hung windows to fit the window tightly against the frame and to decrease air infiltration. See the next page for additional information on caulking and weatherstripping.

#### 2 **SECOND CHOICE:** Install properly designed and fitted storm units following the guidelines on the next page.

#### 3 **THIRD CHOICE:** Retrofit existing windows with additional glass.

Retrofitting can be difficult and must be carried out with great care because it alters the historic window fabric. For all windows, the sash frame needs to be in relatively good condition and of sufficient size to handle the additional glass weight.

Mechanical routing of the frame is usually required to accommodate the additional glass. The extra weight may require additions to the sash weights, for which there must be sufficient room in the weight pockets. For multipane sash, the muntin must also be both wide enough and strong enough to accept the additional glass.

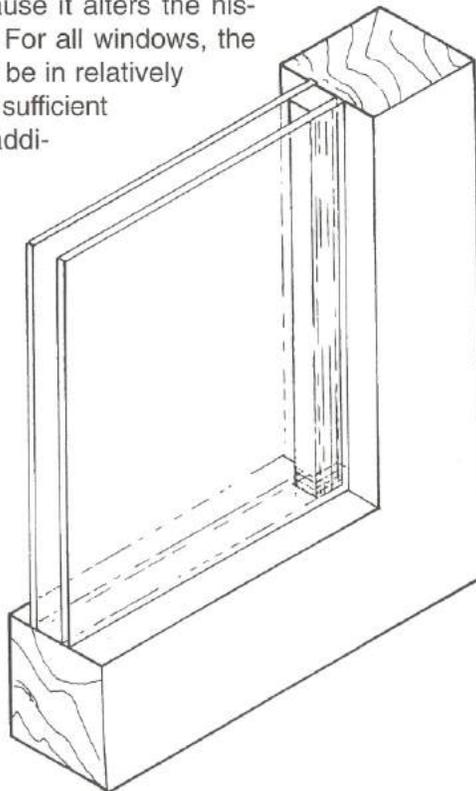

## WINDOWS AND DOORS

### Energy Efficiency in Gettysburg



A common triple track aluminum storm sash on a window in Gettysburg.



Shutters at 126 East Middle Street. Historically, shutters were used to keep the wind and sun out.

### Modern Treatments for Windows

Some modern treatments for increasing the energy efficiency of windows, like "low-E" glass and the use of argon and krypton gas, may be appropriate for historic buildings. They are appropriate when they do not alter the character of the glass or the overall window from its historic appearance.

# WINDOWS AND DOORS

## Weatherstripping and Caulking

Air can leak between a window's sash and frame, between window and door frames and the adjacent wall surface, and where sash rails meet. Weatherstripping fills cracks around doors and windows to provide a tight seal and to eliminate drafts. Caulking seals gaps between building materials to prevent air and water infiltration.

## Potential Areas for Weatherstripping and Caulking:

- Behind the track of window sash.
- Between the joining rails of the upper and lower sash.
- Along the bottom of sliding sash units.
- Around door frames.
- Around the inside perimeter of double hung windows.
- At the meeting rails of double hung sash.
- On the frame and along the full width of the door sill.
- Between corner boards and siding.
- Between sill plate and foundation.
- Any joints between masonry and wood.

## Hints:

- Correct installation of weatherstripping and caulk is essential. Follow the manufacturer's directions.
- Regularly inspect for and replace bent, torn, or loose weatherstripping.
- Joints larger than ½ inch deep and ½ inch wide should receive a foam backer before caulking.

**NOTE:** Storm windows are much more effective than storm doors. Storm doors and entrance vestibules are typically not cost effective. A properly weatherstripped door can outperform a door/storm door combination.

## GUIDELINES FOR STORM WINDOWS AND DOORS

- Wood storm frames are preferred. They can be fabricated to fit any opening and are much more energy efficient than aluminum or vinyl because wood conducts heat more slowly than those materials. Well maintained wooden storms can last over 100 years — much longer than aluminum.



The storm sash on the windows of the St. James Lutheran Church have divisions that match those of the historic windows. This increases the compatibility between the storm sash and the historic window.

- Storm units should completely fill the opening. Any divisions should match existing divisions in the primary unit. Aim to reveal as much of the original unit as possible.

- Storm units should match the shape of the window or door opening. If the opening is arched, the storm unit should be arched.

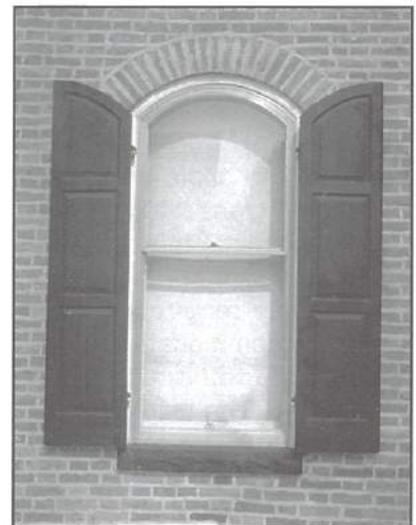

Shutters should match the size and shape of the window opening, like these arched shutters at 270 Baltimore Street.

- Install storm units without damaging the original building fabric. Install caulking to ensure that moisture does not collect between the storm and the primary unit.

- Avoid storms with a natural aluminum finish. They should be painted to match window trim.

## Remember:

Never replace a window or door if repair and maintenance can improve its performance and maintain its originality.

# PORCHES



The building at 249 Carlisle Street, built in 1902.  
Photo courtesy of the Adams County Historical Society.



# PORCHES

## THE PARTS OF A PORCH

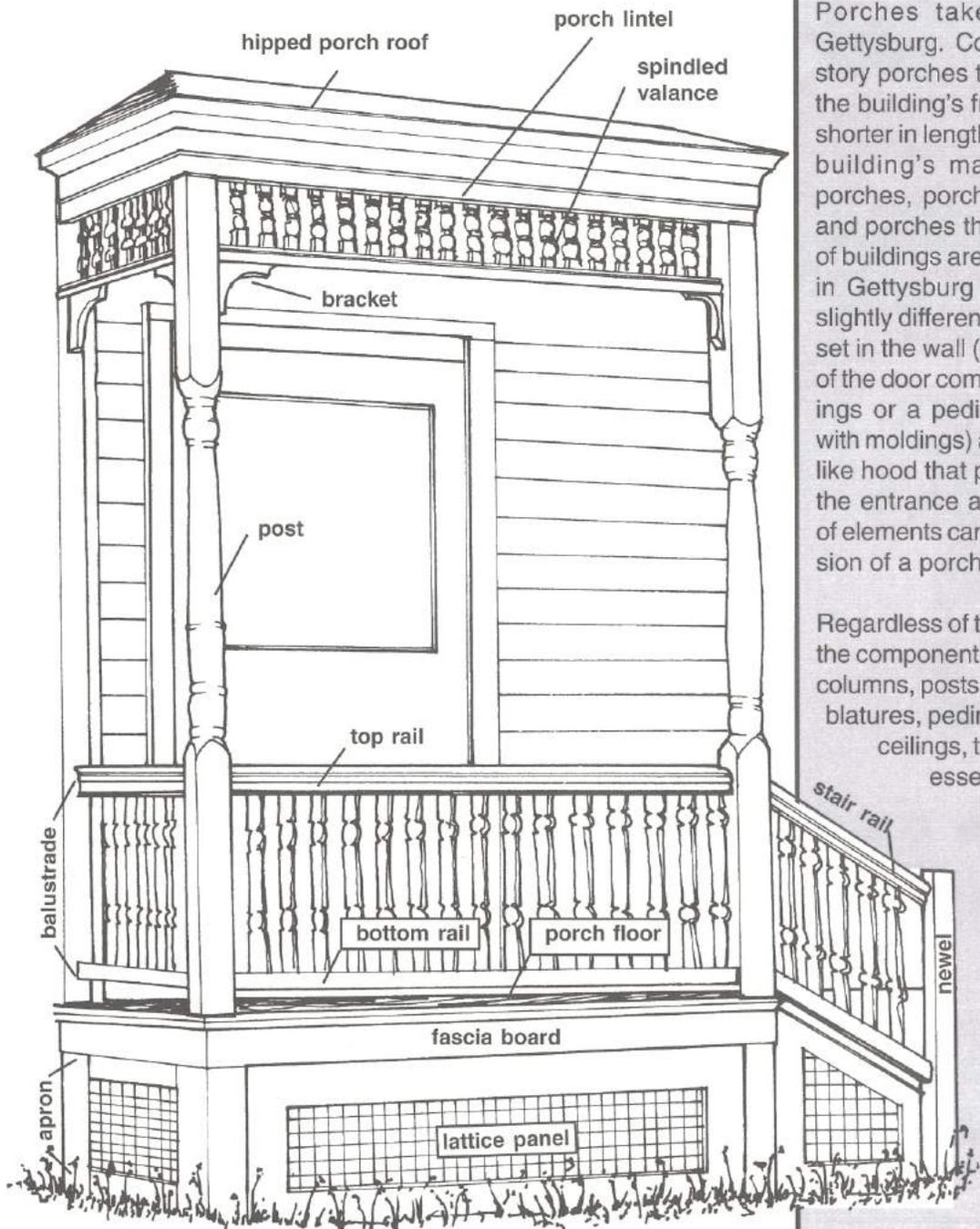

The porch at 26 East Stevens Street.

Porches are among the most visible features of older houses in Gettysburg. They are also some of the most frequently altered features.

Porches take a variety of forms in Gettysburg. Common forms include single-story porches that extend the full length of the building's front wall and porches much shorter in length that extend just beyond the building's main entrance. Two-story porches, porches on side and rear walls, and porches that wrap around the corners of buildings are also found. Many buildings in Gettysburg have porch elements in a slightly different form. Columns or columns set in the wall (called pilasters) at the sides of the door combined with ornamental moldings or a pediment (a triangular element with moldings) above, or simply a pediment-like hood that projects from the wall above the entrance are also common. This use of elements can be considered a simple version of a porch.

Regardless of the size or scale of the porch, the component elements, which can include columns, posts, pilasters, balustrades, entablatures, pediments, stairs, railings, floors, ceilings, trim, and other ornament, are essential to the distinctiveness of houses in Gettysburg.

Many porch elements are protected from the weather by the porch roof. Other porch elements, like stairs and railings, have received hard use and exposure to weather for many years. Consequently, porches require careful maintenance to retain their unique character.

# PORCHES

## Guidelines for Porch Repairs

- Carefully inspect deteriorated porch elements. Replace only those parts that cannot be repaired. For example, the bases of porch columns are often a major site of extensive deterioration. But, a deteriorated column base does not necessarily require the replacement of the entire column.
- Avoid introducing new materials that were not historically a part of the porch. For example, don't replace wooden posts with brick, metal, or vinyl posts, or with other synthetic material.



A deteriorated porch in Gettysburg.

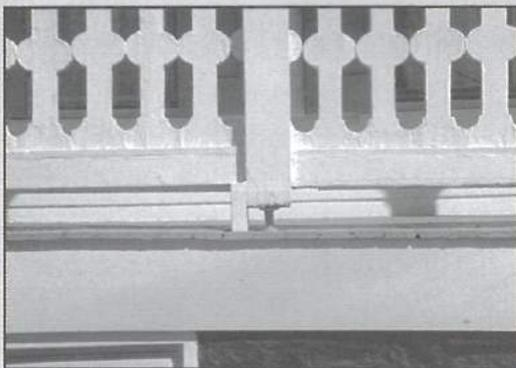

This condition, in which the base of a porch column has been removed due to deterioration and has not been replaced, is common in Gettysburg. After removal, such elements should be replaced with new bases that match the historic element.

## THE REPAIR OF PORCHES

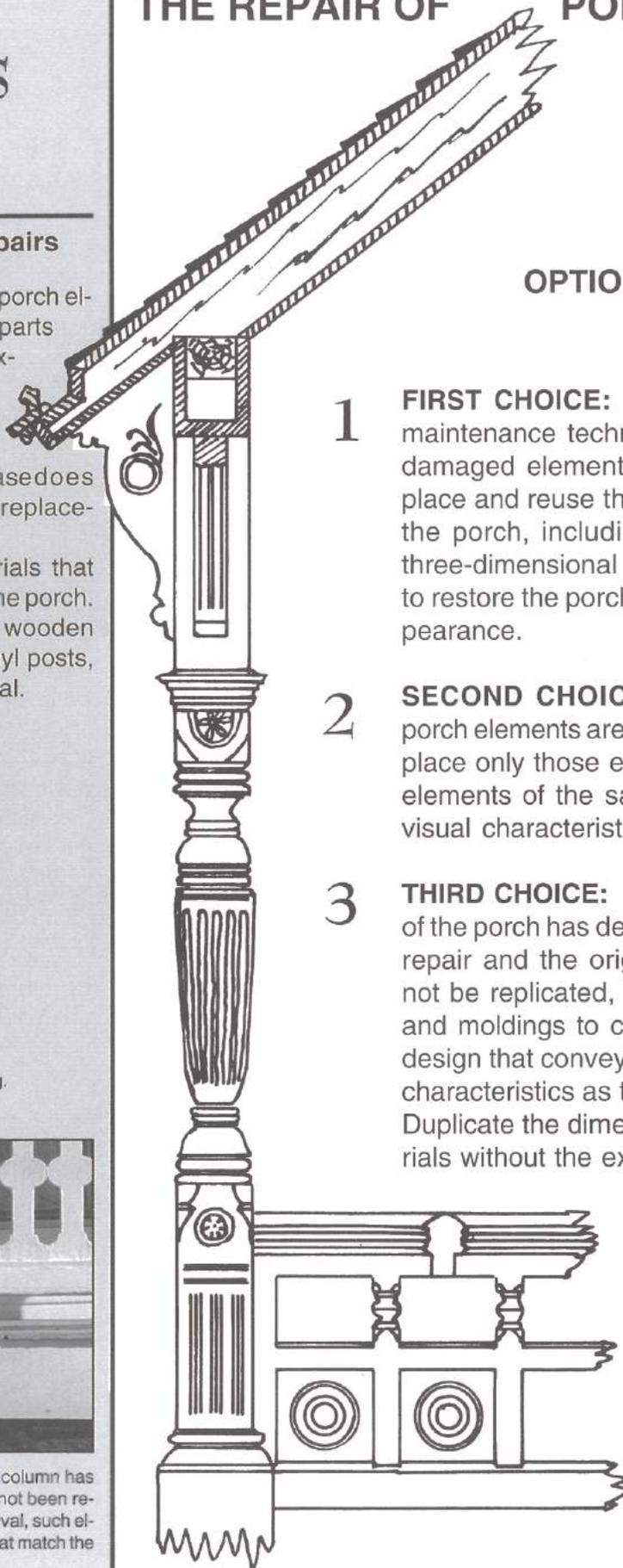

## OPTIONS

- 1 FIRST CHOICE:** Using standard maintenance techniques, repair the damaged elements of the porch in place and reuse the original parts of the porch, including moldings and three-dimensional turned balusters, to restore the porch to its historic appearance.
- 2 SECOND CHOICE:** If individual porch elements are beyond repair, replace only those elements with new elements of the same material and visual characteristics.
- 3 THIRD CHOICE:** If a major portion of the porch has deteriorated beyond repair and the original design cannot be replicated, use stock lumber and moldings to create a simplified design that conveys the same visual characteristics as the original porch. Duplicate the dimensions and materials without the extensive detailing.

Nineteenth century drawing of parts of a porch by architect M. E. Stallsmith. Courtesy of the Adams County Historical Society.

## ENCLOSING PORCHES

Porches were meant to be open exterior spaces. Enclosing them is a radical change on any side of a building, and should never occur on the front of a building. If a porch must be enclosed on a side or rear wall, the options and guidelines listed below should be considered.

### OPTIONS

- FIRST CHOICE:** Enclose a porch on a side or rear elevation using temporary elements, such as screens that can be removed at the end of the summer or windows that can be removed at the end of the winter.
- SECOND CHOICE:** Enclose a porch that is on a side or rear elevation using recessed translucent materials with compatible framing. See the guidelines below.



An enclosed porch at 250 Carlisle Street. The recess of the enclosure behind the porch columns maintains the open character of the porch and preserves the integrity of the historic porch materials.

#### Guidelines for Enclosing Porches:

- Any changes or additions to historic porches should be reversible without damaging historic materials.
- The enclosure should be constructed primarily of translucent materials, such as clear glass or screen.
- Recess added materials behind the existing porch structure to assist in maintaining the open character of the historic porch.
- All added material should have minimal vertical and horizontal framing elements. Framing elements that are present in the added material should match the locations of existing horizontal and vertical porch elements.
- Screen framing members should be painted to blend with the screen rather than the porch framing.
- Retain all salvageable elements, ornament, and detailing in place.
- Ensure that the closed porch still appears to be a porch, not a closed room.

## PORCHES

### Enclosed Porches of Gettysburg



By enclosing this porch with a wall and windows, the porch has been made to look like a closed room.



Although this screened enclosure at 123 West Broadway uses many framing members, the screening is recessed from the structural members of the porch, and the open character of the porch is maintained.

#### Remember:

A replacement porch of similar visual character is better than no porch at all.

# PORCHES

## Options for Replacement Balustrades

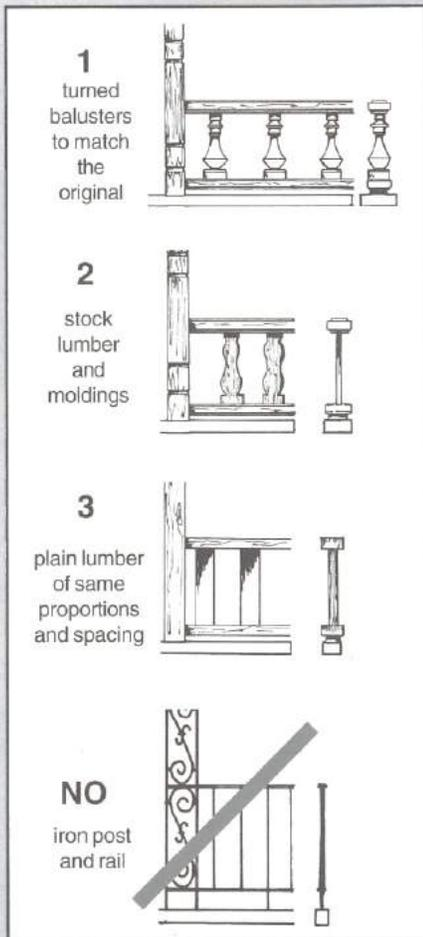

A wooden porch balustrade (right) and an iron stair railing (left) in Gettysburg.

## STEPS, RAILINGS & BALUSTRADES

Steps need maintenance because they receive heavy use, are constantly exposed to the weather, and are in close contact with the ground. If your steps are deteriorated beyond repair and must be replaced, follow these guidelines:

**Rebuilt steps should continue the materials of the porch:**

- Wood stairs for frame houses are historically correct. They should not be replaced with concrete.
- Brick steps are typically appropriate only for porches with brick posts and foundations.
- Stone steps are typically appropriate only for porches with stone posts and foundations.
- Concrete steps are rarely appropriate for historic houses.

**Rebuilt steps should maintain the historic orientation:**

- Steps were typically, but not always, positioned in line with the front entrance.

**Replacement step railings should match the balustrade of the historic porch in material and detailing:**

- Wrought iron or aluminum railings and columns are not good substitutes for wood elements. Their lightweight appearance is inappropriate.
- Most Victorian porches had step balustrades that ended in a newel similar to the porch columns.

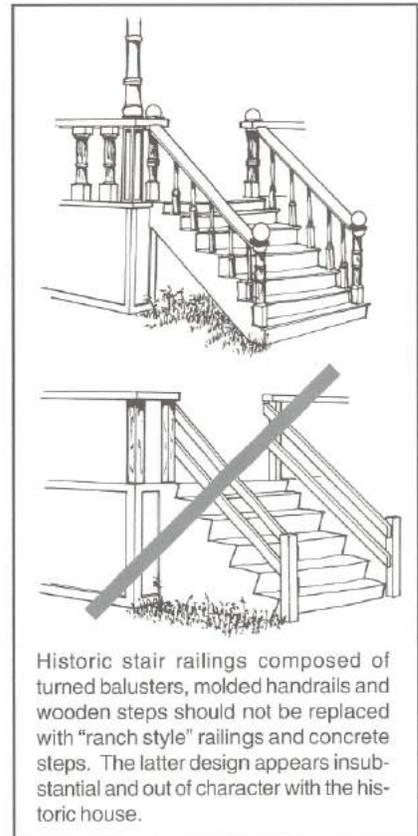

Historic stair railings composed of turned balusters, molded handrails and wooden steps should not be replaced with "ranch style" railings and concrete steps. The latter design appears insubstantial and out of character with the historic house.

**Replacement balustrades should maintain the overall character of the historic balustrade:**

- Don't replace a turned balustrade with latticework.
- Don't replace a turned balustrade with solid panels.
- Millwork to replace turned balustrades can be made. Check with HARB for a list of suppliers.



## When is a New Porch Appropriate?

1. When it can be documented by historical, pictorial, and physical evidence that a porch of the type to be erected once existed on the house.
2. When it can be determined that houses of similar type, style, and date of construction were originally built with porches of the type to be erected.

### Determining if a Porch Existed:

- Railings, floors and roofs may have left shadows on walls or trim. Check beneath newer siding.
- Historic maps and photos may show earlier porches or steps.
- Look for similar houses in your neighborhood and compare porches. But, remember that all porches are not necessarily original or historic.
- Check basements, attics, and other storage areas for original pieces.
- Ask your neighbors.

### Guidelines for Adding New Porches:

- Thoroughly consider the factors of size, shape, scale, profile, massing, materials, color, and texture in the design.
- Avoid hiding, damaging, destroying, or otherwise negatively affecting existing historic materials and features of the original building.
- Build a wood porch if the house has wood siding or wood shingles. For a masonry house, the porch may be wood or masonry. Check style guides and similar houses to determine which is more appropriate.

# PORCHES

## Porch Alterations



The porch at 243 Chambersburg Street features turned posts, a spindled valance and ornamental brackets.



Most of the historic elements of this porch have been removed and replaced with an iron trellis post and valance.

# PORCHES



A door with a gabled hood.

## Priorities for Gettysburg Porches

- Ensure that porches are never left unpainted and are not treated with a “natural” finish. Treated wood should be painted following its initial period of weathering.
- If a porch must be enclosed, ensure that the enclosure does not appear solid.
- Avoid constructing entrance porches or door hoods where they never existed. Such additions give buildings a false appearance and diminish the importance of the buildings that do possess those elements.
- If a new porch must be added, build it on a side or rear wall that is not visible from a public street or alley.

## DOOR HOODS

Many buildings in Gettysburg have hoods over the entrance door rather than full porches. These hoods may be simple or highly ornamented. They may be rounded or triangular in shape. Such hoods offer a degree of shelter and add detail and interest to the entrance and the overall building. Remaining door hoods should be retained.



A pedimented door hood with sunburst ornament at 211 North Washington Street.



A door hood with a hipped roof at 48 North Washington Street.



An arched door hood at 218 Chambersburg Street.

# ROOFS

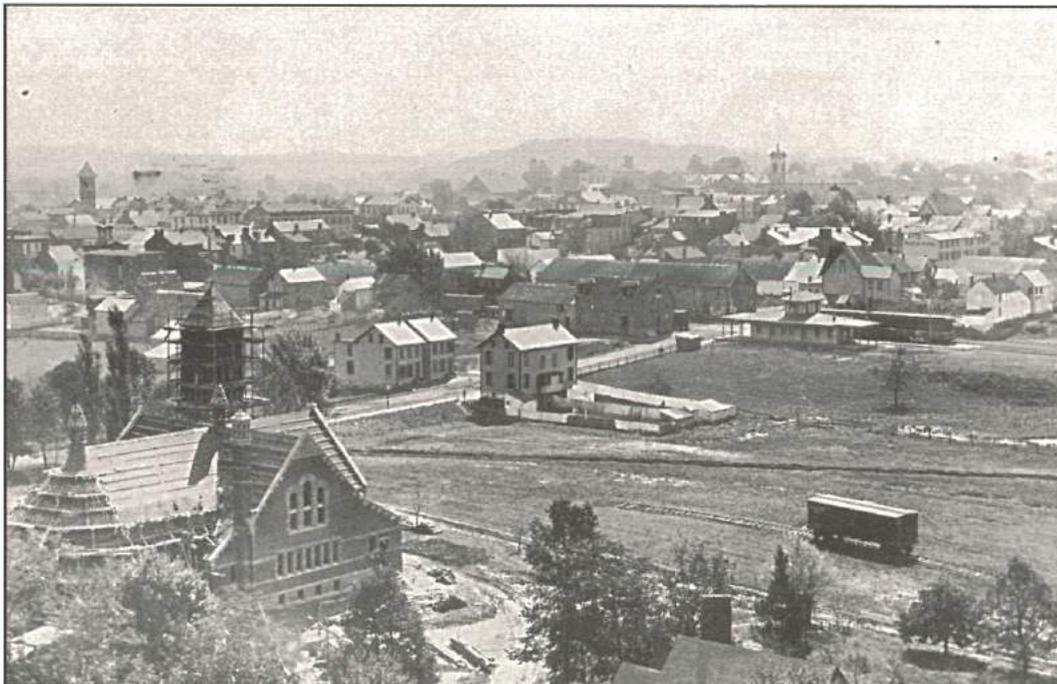

Gettysburg from the tower of Glatfelter Hall, 1889.  
Photo courtesy of the Adams County Historical Society.



# ROOFS

## A HOUSE WITH A PATTERNED SLATE MANSARD ROOF



Roofs are important because they offer shelter to the activities in the building below. Roofs are highly vulnerable to the damaging effects of wind, rain, snow, and heat from the sun, and a weather-tight roof is a necessity for the preservation of any structure — new or old. Problems inherent in the design of a historic roof can be controlled through the use of good materials and regular maintenance.

Although the functional requirements of a roof are important, roof design often goes beyond the merely functional and contributes considerably to the character of the building. The shape, size, color, pattern, and detailing of a roof are important elements that help define the building's character and add interest to the streetscape.

entrance porch  
turned post  
double doors

Nineteenth century drawing of 105 East Middle Street by M.E. Stallsmith. Courtesy of the Adams County Historical Society.

# ROOFS

## Typical Roof Shapes

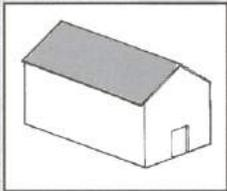

Front Gable

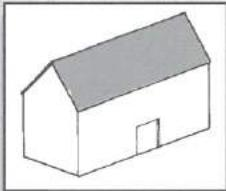

Side Gable

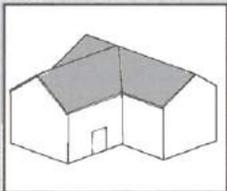

Cross Gable

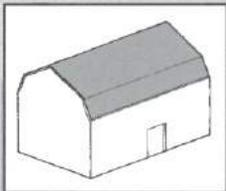

Gambrel

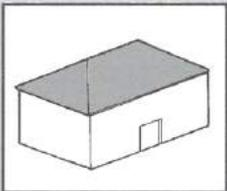

Hipped

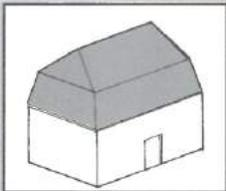

Mansard

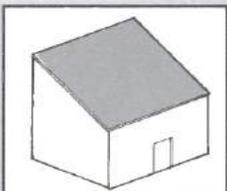

Shed

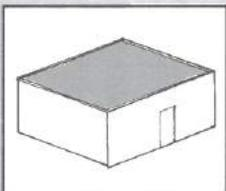

Flat

## SIGNIFICANCE OF FORM

Roofs, even those of simple form, help to determine the character of a building. The combination of the size, shape, and slope of a roof create a unique silhouette. Most houses in Gettysburg have gabled roofs. Other typical roof shapes include the gambrel, hip, mansard, shed, and flat roof.

Builders were guided by practical considerations in their selection of roof shapes. For example, Gettysburg builders often chose steeper slopes to shed snow and rain. Sometimes the need for attic space prompted the construction of a gambrel or mansard roof, which provided more space than a flat or gabled roof would. Ease of construction prompted other builders to choose a simple gable over a more complex mansard.

Despite the importance of such practical considerations, certain roof shapes became associated with specific architectural styles in Gettysburg over the years. Neo-classic houses typically had low pitched gabled roofs, which reflected the pediments of classical buildings that inspired the style.

Gothic Revival buildings used steeper slopes and complex silhouettes to reflect the more picturesque feel of medieval buildings. Second Empire buildings, the style most reliant on roof shape for identification, all used the French-inspired mansard roof. Queen Anne buildings typically used complex rooflines to achieve a picturesque quality, and Colonial Revival buildings, to better imitate their earlier Colonial counterparts, reverted to the simpler gable and hipped forms.



The 200 block of Chambersburg Street showing a predominance of gabled roof forms.

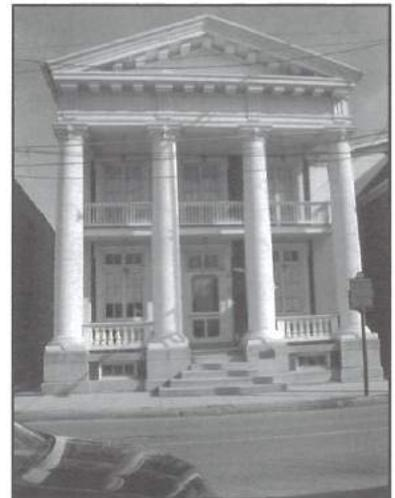

The building at 157 North Washington Street, featuring a classically inspired pediment and columns.



A mansard roof at 783 Baltimore Street.

This combination of practicality and stylistic influence created buildings in Gettysburg that relied heavily on the shape of the roof for character definition. Because roof shape is so important to the character of the building, the guidelines contained in this chapter should be followed when undertaking roof repairs and alterations.



A gabled roof at 311 Carlisle Street enlivened with the shapes of an eyebrow dormer, a large gabled dormer, chimneys, and a tower.



Patterned, multicolored shingles on the cross-gabled roof at 220 Carlisle Street.

## The Significance of Roofing Material Appearance

Like the shape and slope of the roof, roofing materials are also chosen for practical and aesthetic reasons. The choice of materials depended upon a number of factors, including availability of materials, availability of skilled artisans, roof pitch, and weather conditions. Steep roofs require materials such as shingles, slate, or tile to shed water. A flat roof calls for an unbroken surface. Moderately sloped roofs can be covered with metal or asphalt shingles.

In addition to providing a weather-tight surface, roof covering materials can add color, texture, and pattern to the roof. Shingles can be used in a variety of shapes and colors. Wood, slate, and metal offer variety in texture. The seams of metal roofs and the ways in which shingles are laid can create patterns of great visual interest. This combination of practical and aesthetic considerations has produced roofs that contribute to the overall architectural character of Gettysburg.

# ROOFS

## General Guidelines for Roof Alterations

- The form and pitch of historic roofs should be maintained on all sides visible from public streets or alleys.
- Original roofs should not be raised to accommodate additional stories.
- Elements should not be added to historic roofs if they will change the overall silhouette as seen from public streets or alleys.

## Determining Original Materials

If you are unsure of the material originally used on your roof, check to see if there are other materials under the current roofing materials. These may be the original roof covering. Also check historic photos, ask neighbors, and look for similar buildings in your neighborhood.



Patterned slate shingles on the mansard roof at 105 East Middle Street.

## Guidelines for roof material details

- If new roofing details will be readily visible, their appearance should be based on architectural evidence or on historic prototypes.
- The spacing of the seams on a standing seam metal roof will affect the building's overall scale and should therefore match the original dimensions of the seams.

# ROOFS

## Guidelines for Determining if Roof Materials Should Be Replaced:

- Calculate the amount of damaged and missing material. If the amount is less than 20% and the roof is in generally good condition, the material should be repaired. If the amount is over 20%, consider replacement. If the amount is near 20%, consider the age and condition of the roof in relation to its expected serviceable life. Remember, the older the roof gets, the more repair it will need.
- Don't replace an entire roof if only one slope is deteriorated. If one slope has weathered more heavily than the other slopes, consider replacing it and repairing the others.
- Check for the source of any active leaks. Gutters, valleys, and flashing are at fault more often than roof covering materials. Don't replace materials if other features are the source of leaks.
- Check the roof rafters and sheathing for moisture stains and rot. Deteriorating materials can hold moisture that will cause adjacent wood to rot. Replace wood and structural members as necessary. If only underlying roof elements are deteriorated, attempt to carefully remove and then reuse the historic roof covering materials once the underlying trouble is resolved.
- Check to see if the fasteners are corroding, loose, or missing. Replace the fasteners and reuse the materials.
- Consider the availability of replacement materials.

## ROOF COVERING MATERIALS, DETERIORATION & REPLACEMENT

The most commonly used roofing materials in Gettysburg are slate, metal, and asphalt shingles. Each of these materials is described below. Information is also provided on typical patterns of deterioration and replacement options.

**SLATE:** Slate began to be used during the Colonial period, but its initial use was limited because of cost. In the mid-nineteenth century, canals and railroads made slate more accessible and economical, and it became more widely used. The color and texture of slate varies according to its place of origin. Grey, blue, and green shades are available; in Gettysburg, grey and blue-gray slates are common. The remaining slate roofs in Gettysburg are a significant historic resource; their preservation should be a priority.

**Deterioration:** The most typical problem with slate is with the nails used to install it. Iron nails usually fail before the slate does. If this happens, reattach the historic slates with copper nails and copper flashing. Another problem with slate is delamination. As slate weathers, its surface is slowly chipped away. The slate scales and thin layers flake off. The slate eventually becomes soft and spongy and the inner layers begin to fall



A  
deteriorating  
slate roof in  
Gettysburg.

apart. In this condition, slate will hold moisture and can cause adjacent wood to deteriorate. Slate in this condition should be replaced. Missing slates or slates with visible holes, cracks, or breaks should also be replaced. Slates that have slipped should be reattached.

A simple method to determine the condition of slate is to press firmly on the slate with your hand. Sound slates will be unaffected. Deteriorated slates will feel brittle and crack.

**Replacement Materials:** A number of manufacturers continue to offer new natural slate in a variety of shades. Salvaged slate is also available from a number of suppliers. If you choose to use natural slate, find a supply that matches your roof and get enough for current needs and for future repairs.



A variety of synthetic slate look-alike products are also available on today's market. These products have a ceramic, concrete, fiber-cement, or mineral-polymer base. Appearance varies among the types and manufacturers. Review as many samples as possible before choosing one.

**Cautions:** Beware of roofers who insist that slate roofs cannot be repaired. Be sure to hire a roofer who specializes in slate. Note: Clay tile roofs are similar to slate roofs in most respects. Slate, asbestos and clay tiles are fragile — don't walk on them.



A wood shingle roof on the Dobbin House.

**WOOD SHINGLES:** Wood shingles of white pine, oak, elm, cypress, redwood, and red cedar were used for roofing throughout American architectural history. Because they were a fire hazard, wood shingles were typically replaced as other more fire resistant materials became available. In the second half of the nineteenth century this typically meant metal sheeting. As the Shingle Style emerged at the turn of the nineteenth century, wood shingles again gained popularity.

**Deterioration:** Wood shingles are subject to all the typical sources of wooden wall deterioration. (See that chapter earlier in this guide.) If wood shingles appear thinned, eroded, cracked, cupped, split, spongy, or warped, the shingles are probably no longer providing sufficient weather protection. If only a few shingles are missing or damaged, replace them individually. Splits or holes in wood shingles can be treated with a piece of aluminum or galvanized steel under the shingle and roofing cement in the hole or crack. Moss and fungi on wood shingles hold moisture that can speed deterioration. Attempt to dry the roof by trimming trees that block the sun, and consider fungicide treatments. If a significant amount of water damage is visible in the attic, consider shingle replacement.

**Replacement Materials:** Southern pine, white pine, white oak, red cedar, and white cedar shingles are available today for replacement roofing. Fiber-cement shingles intended to match the appearance of wood shingles and wood shakes are also available.

# ROOFS

## Choosing Replacement Materials

When choosing replacement materials cost and the life of the material are important factors. For example, slate and tile will last about three times longer than asphalt shingles. Additional factors for consideration include the fact that asphalt shingles will increase in price each time they are purchased, and, if scaffolding is required, it will be required two additional times, as well.

Replacing historic roofing materials in kind is preferred. Most historic materials continue to be available today. In addition, new technologies are making possible the fabrication of a number of substitute materials that more closely duplicate the appearance of historic materials. As these technologies continue to improve, the Gettysburg HARB is open to considering them as replacements for materials that are beyond repair when economic factors are a consideration. Samples of these materials should be obtained for review. Remember, although most paint color is not reviewed by the Gettysburg HARB, the color of roofing materials is reviewable.

### Guideline for Choosing Replacement Materials

*If the roof is readily visible, the alternative material should match as closely as possible the scale, texture, and coloration of the historic roofing material.*

# ROOFS

## Guidelines for Replacement Roof Materials

1. If the roof is weathertight, do not replace materials.
2. Before replacing a roof, identify the historic material, configuration, detailing, and installation.
3. Fix all structural problems before re-roofing. Ensure that gutters, downspouts, and flashing operate properly.
4. Replace old shingles with new shingles in the original material. For example, replace slate shingles with slate shingles.
5. If replacing an entire roof, replace with the same type of material. For example, don't replace shingles with sheet metal roofing.
6. Attempt to duplicate the variety of colors, textures, and patterns of the original roof.
7. Avoid roofing over an existing roof.
8. Roofing projects pose significant dangers to personal safety. Be sure to take all necessary precautions, or hire a qualified professional to undertake the work.
9. Reuse such intact roofing material as slate or tile when only the substrate requires replacement.

**METAL:** Metal roofing, including lead, copper, tin-plated iron, and terne plate, began to be used in the nineteenth century. After about 1850, when manufacturing facilities for these products were established in the United States, sheet metals became more popular. To cover roofs of low or moderate pitch, individual sheets are joined by upright (standing) or flat seams.

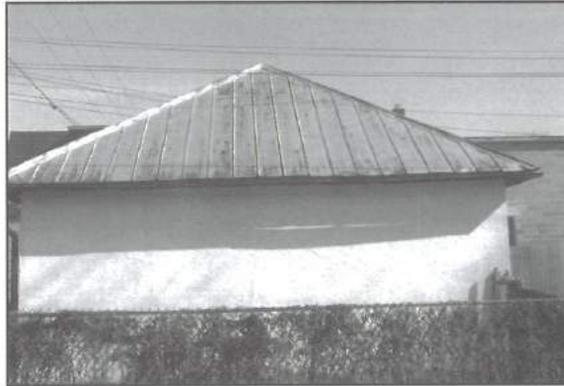

A metal roof on a garage in Race Horse Alley.

**Deterioration:** Metal roofing should last as long as it is painted. Historically, tin plating or galvanizing took care of this, but plating can wear, and once worn, iron will rust. Metal roofing can also deteriorate from chemical action caused by pollution and acid rain, which cause pitting and streaking. Because metal expands and contracts with changes in temperature, metal roofs are subject to thermal movement, buckling, and warping. These problems can lead to cracks in joints and open seams. Metal roofs are also subject to corrosion that occurs when incompatible materials, such as copper sheets and iron nails, are in direct contact. If metal roofing is severely rusted, if it contains numerous holes and splits, if several sheets have buckled or warped, if edges and joints are disfigured, or if there are large areas of thin or worn material, consider replacing the material in kind. If only a few spots have rusted or if a few holes exist, proceed with repair rather than replacement. If a single sheet has slipped, repair it.

### Replacement Materials:

Sheet aluminum, copper, lead-coated copper, galvanized metal, painted steel, terne plate, and zinc are all available today, as are a variety of metal coatings. Metal shingles, to match those used historically, are available, but no closely matching substitutes are available for sheet metal. Fix all structural problems before reroofing. Ensure that gutters, downspouts, and flashing operate properly.



A steeply-pitched metal roof at 115 Chambersburg Street.

**ASPHALT:** Asphalt shingles were introduced to the building market around 1890 and gained wide popularity by about 1910. Asphalt shingles are made of asphalt-saturated felt or fiber-glass, embedded with mineral granules to reflect the heat and ultraviolet rays of the sun. They were considered a good roof

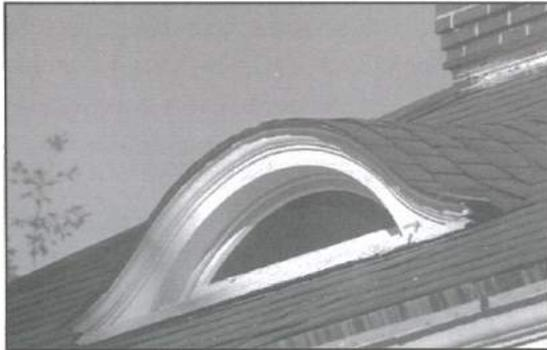

An eyebrow dormer on the asphalt shingled roof of the cemetery gatehouse.

ing material because of their relative inexpensive cost and their fireproof quality. If your building was constructed before 1890 and it currently has asphalt shingles, the roof was probably originally covered with slate, wood, or metal.

**Deterioration:** Asphalt shingles can deteriorate due to inappropriate installation. Wind can lift and dislodge them. Over time, shingles may curl and lose their mineral covering. If more than 20% of asphalt shingles have curled or warped, if the mineral granule surface has been abraded, if they are cracked or dried out, if the overall surface is lumpy, if moss covering is pervasive, or if the surface has been numerous and repeatedly patched, consider replacement. Remember that trees may stain light colored shingles.

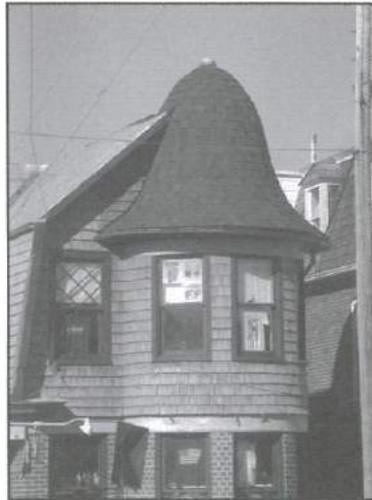

A bell-shaped roof covered with asphalt shingles at 531 Baltimore Street.

**Replacement Materials:** Most asphalt shingles available today are reinforced with fiberglass. These are an acceptable replacement for the earlier felt-based shingles. Manufacturers are now producing thicker asphalt-based shingles to suggest the appearance of natural materials like slate and wood. These are not appropriate for twentieth century houses that were originally roofed with asphalt shingles. For all buildings, beware of dramatic colors on the roof; they may make it more difficult to choose compatible colors for your building later.

## ROOFS

### Flashing

Flashing is the thin metal material used to prevent water penetration into areas of your roof that are difficult or impossible to protect with the roof covering alone. Most roof leaks are caused by deteriorated flashing; leaks don't necessarily mean that the roof covering material (such as slate) is deteriorated and must be replaced.

Flashing is typically installed around chimneys, dormer windows, vents, and at the intersections of additions, porches, bay windows, and parapet walls. Copper, terne, aluminum, steel, and lead are all used for flashing. Copper has the longest life. Steel has a shorter life span than copper. Aluminum has a shorter life than steel and easily tears, twists, and punctures.

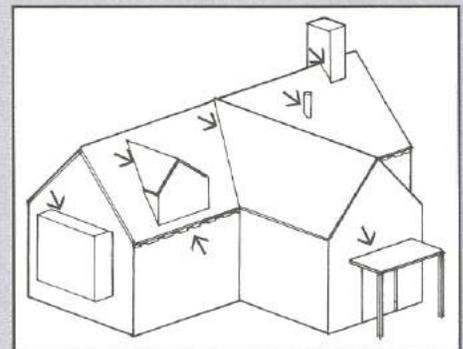

Typical locations for flashing installation.

Check the condition of flashing whenever you are making roof repairs. If a new roof is being installed, install new flashing if the existing material is not expected to last as long as the new roof.

# ROOFS

## Guidelines for Rooftop Features

Some buildings include decorative and functional elements that are attached or built into the roof that can be significant in defining the character of the building. Typical rooftop features are cresting, finials, weathervanes, cupolas, dormers, and chimneys. The guidelines below should be followed when treating any features of this type.



Finials atop the towers of Trinity United Church of Christ.

- Repair rooftop features before replacing them.
- If deterioration demands replacement, replace rooftop features with features based on the original design in the original material.
- Avoid removing a rooftop feature without replacing it.
- If matching the design of the historic feature is not feasible, create a simplified design based on its size, scale, massing, and appearance.
- Avoid adding features that will change the roof configuration. If elements must be added, place them on slopes of the roof not visible from the street.
- Avoid adding new rooftop features that create a false historical appearance based on insufficient documentation.
- New features should be compatible in size, scale, material, color, and detailing to the historic building.



The cupola of the Reading Railroad Station.

## OPTIONS FOR ROOFING

- 1 FIRST CHOICE:** Clean and maintain gutters, downspouts, and flashing. Reattach loose shingles. Ensure that nails and other fasteners are secure and without corrosion. Fill small cracks in sheet metal with caulk or sealant — a temporary repair.
- 2 SECOND CHOICE:** If less than 20% of the slate or wood shingles on one slope are damaged, replace the damaged or missing shingles with new shingles that match the original in material, size, shape, color, and other visual characteristics.



A deteriorating asphalt shingle roof.

- 3 THIRD CHOICE:** Replace damaged or missing roofing material with new material that matches the original on the prominent portions of the roof. Replace with a compatible substitute material in less prominent areas. If the roofing substrate will be replaced, be sure to re-use original undamaged materials when reroofing.
- 4 FOURTH CHOICE:** If new shingles in the original material cannot be obtained, replace missing shingles with new shingles in a substitute material that conveys the same visual appearance as the original shingles. If the original shingles were varied in color, attempt to reproduce this historic color variety. If the original type of sheet metal cannot be obtained, replace the original with new sheet metal in a substitute material that conveys the same visual characteristics as that of the original.

## ROOFTOP FEATURES

**Chimneys:** One of the main elements in the visual profile of a house is its chimney, and many chimneys were originally built to match the architectural style of the house. For these reasons, the character of a chimney should be retained when improvements are being made.

Because of their exposed position, chimneys are particularly susceptible to the effects of wind, rain, and frost. Brick and stone chimneys are subject to the same problems as brick and stone walls. (See the masonry chapter of this manual for additional information.) Deteriorating flashing can also be a problem. (See the information on flashing earlier in this chapter.) Even if chimneys are no longer in use, they should not be removed or replaced.

**Snow Guards:** Snow guards, also called snowbirds, are often found on Gettysburg roofs. They were traditionally installed to avoid dangerous slides and to protect gutters, eaves, and cornices from snow and ice damage. (Some early builders installed them to increase the insulating effect of snow on the roof.) Many of these elements were decoratively designed. They are often found near the eaves at the lower edge of slate and metal roofs in staggered rows, or on steeper roofs in greater quantities. The number of snow guards used depended on the slope of the roof. Iron or copper wire were typically used.



Snowbirds on the slate roof at Brua Hall, Gettysburg College Campus.

**Dormers:** Avoid adding dormers to prominent slopes of the roof. If they are added on other slopes, they should be in proportion to the building. New dormers should have roof forms that match those of existing dormers, or if historic dormers are not present, the dormer roof should match the house roof or should be compatible with it. (See the Windows and Doors chapter of this manual for more information on windows.)

**Skylights:** Skylights were not a part of the historic design of houses in Gettysburg. If skylights must be added, they should be added only to roof slopes that are not visible from public streets or alleys. They should be flat and their placement should be compatible with the other windows of the building. Installation should not damage historic materials.

## ROOFS

### Chimney Styles

Many buildings were designed with chimneys that matched the style of the building. Such chimneys are character-defining features and should be retained.

Chimneys on Federal style buildings were typically tall, plain shafts, sometimes with molded caps. Sometimes two chimneys were joined to form the letter H in gable end walls. These designs were copied in the nineteenth and twentieth centuries for buildings constructed in the Colonial Revival style.



An H-shaped chimney at 202 Chambersburg Street.

Gothic Revival chimneys were often divided into a base, middle, and cap. They often had round or octagonal shafts, and were treated with patterns or brickwork. Multiple stacks might be grouped together on a platform.



A Gothic Revival chimney at 451 Baltimore Street.

Queen Anne chimneys used unusual shapes, fanciful embellishments, modeled brickwork, protruding shelves, variegated patterns, pilasters, and stringcourses. This degree of detail added to the visual complexity of the designs of this time period.



A Queen Anne chimney at 208 Baltimore Street.

# ROOFS

## Gutters and Downspouts

Gutters and downspouts have been used for decades to carry water off the roof and away from the building. Some early 19th century houses were equipped with built-in gutters. If your house has them, they are the best option for removing water from your building. Make every effort to maintain and retain the system in operating condition.

Gutters and downspouts have been made of wood, copper, galvanized steel, aluminum, and vinyl. Historic wood and copper gutters and downspouts are relatively rare and should be preserved. Copper gutters are durable, they don't need painting, and they take on a natural patina that protects them from deterioration. Galvanized steel with soldered joints is more economical than copper. Aluminum is less durable than steel and dents easily. Vinyl becomes brittle and may fracture in cold temperatures.

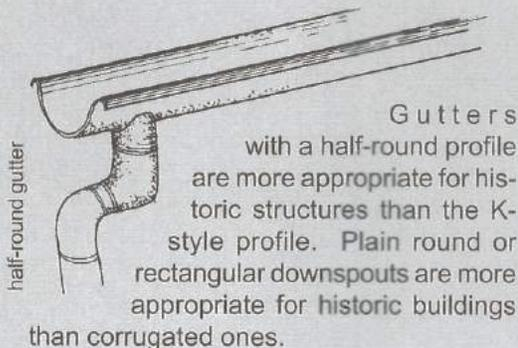

Regularly cleaning gutters and downspouts, patching holes, and mending broken or loose elements will protect the roof and associated features. If additional gutters and downspouts are required, they should be installed on walls that are not readily visible from public streets or alleys. If they must be installed on main building walls, painting them the color of adjacent building materials will help hide them.

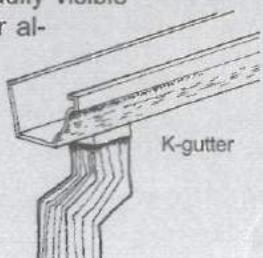

## WHERE THE ROOF MEETS THE WALL

The part of a building where the roof meets the wall is often treated with ornamental elements. Sometimes elaborate, often simple and refined, these elements contribute significantly to the character of a building. They may include simple boards, moldings, panels, cornices, brackets, and ornamental brickwork. Gables, the upper portion of a wall at the end of a roof extending from the eaves to the ridge, often include these elements, as well. In addition, gables often incorporate windows and vents and related trim, siding and/or shingles, stickwork, bargeboards, finials, and other ornamental details.



Gable ornament at 115 North Stratton Street.

All of these elements are subject to water damage, especially from water entering at the joint between the wall and the cornice or molding materials. Due to the distance from the ground to these elements, this damage often goes undetected. See the sections of this manual on windows, wooden walls, and masonry walls for additional information on deterioration and treatment.

Don't remove these elements simply because pieces are missing or damaged. Instead, look for replacement pieces or stock elements that could be used as substitutes. Never cover these elements with aluminum, vinyl, or other materials. This hides the important architectural elements and increases deterioration.

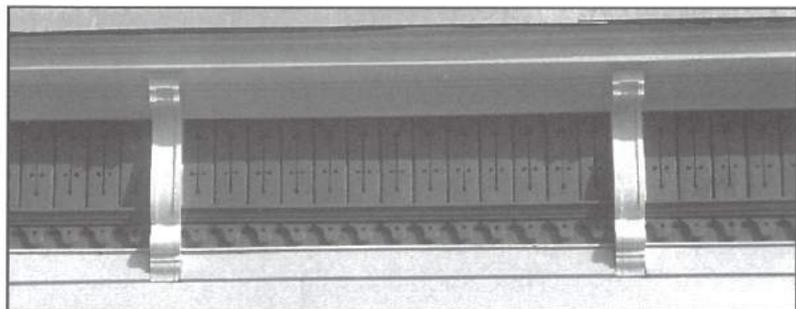

A detail of the cornice at 165 North Stratton Street.

# EXTERIOR COLOR & PAINT



Buildings near the current site of 151 York Street around 1910.  
Photo courtesy of Ray Culp.





# EXTERIOR COLOR AND PAINT

## HARB Approvals

Perhaps no other historic district issue is more controversial than that of COLOR. Color preference is a personal matter, and most property owners don't want to be told what color to paint their homes.

In Gettysburg, approvals are **NOT** required for the selection of paint **color** because paint color is not permanent. Approvals **ARE** required for:

- The selection of **color** when the color is permanent to the material being applied to a building, and
- The application of **paint** to previously unpainted brick, stone, or masonry buildings.

For example: HARB approval is **not** required for the selection of a color to paint your wood porch; but, HARB approval **is** required for the selection of the color of shingles for your roof or artificial siding for your walls.

When it is time to paint, you can determine exactly which colors were applied to your building in the past and recreate them, or you can create new color schemes for your building.

Included in this section is information on colors that are appropriate for the various historic styles that are found in Gettysburg and suggestions on appropriate painting techniques.



A multicolored painted building at 139 Carlisle Street.



Painting at 259 Baltimore Street.

# COLOR CHOICE AND PLACEMENT

## Methods for Choosing Colors

- If you want to reproduce exactly the colors used on your building in the past, you may wish to have an expert analyze chips of paint.
- Alternatively, you could choose colors for your building from the range of colors that were used during the time period in which your building was built.

The table on the next page outlines the colors that were typically used on buildings of the styles and periods indicated. This information can be used to:

- Choose colors for materials or elements to be added to your building, such as roof shingles and artificial siding or shutters,
- Or to select historically appropriate paint colors for your building, and to determine where to place those colors.

## General Guidelines

- Color can emphasize or de-emphasize architectural elements: darker colors recede and make your building look smaller, brighter and lighter colors stand out and make your building look larger.
- Color can be used to tie all the parts of a building together.
- Many houses require only two colors of paint; houses with more detail may require three colors. Few houses are ornate enough to require more than three colors.
- Appreciate the natural color of unpainted masonry.
- Pick your colors in daylight.
- Building style, period of construction, materials, and setting contribute to the appropriate choice of paint color. Consult the table for basic color guidelines.

## REPAINTING YOUR HISTORIC HOUSE:

### OPTIONS:

- 1 FIRST CHOICE:** Sometimes, the appropriate procedure is no treatment at all. Don't repaint if cleaning is all that is required.
- 2 SECOND CHOICE:** Paint only those portions of the building that have deteriorated. For example, repaint only the deteriorated trim if the walls are in good shape. Or, paint only the deteriorated south wall if the other walls are in good shape.
- 3 THIRD CHOICE:** Proceed with removing deteriorated paint to the next sound layer by hand scraping and hand sanding, and repaint following the guidelines in this manual.
- 4 FOURTH CHOICE:** Strip all layers of paint down to bare wood. Before removing all the paint, conduct a paint analysis to obtain all historical information from the building before obliterating evidence of the historical paints and their sequence. Remove paint using chemical strippers or electric heat plates only as necessary to remove failed paint layers.



Peeling paint in Gettysburg.

# TYPICAL COLOR COMBINATIONS FOR HISTORIC BUILDINGS

Although approvals are not required from the HARB for paint colors, the following information is provided for those property owners who want to choose colors that were used during the period their building was constructed. See "Where to Go for Help" for additional sources of information on choosing paint colors.

## BODY AND TRIM COLOR

## EXAMPLES

**BODY:** Shades of white, pale blue, yellow, gray, buff (to imitate marble prototypes). **TRIM:** Dark green, red, brown, black, off-white. Door dark green, medium blue, black, white, dark red. Porch color similar to body.

 White or yellow body, white trim, dark green shutters, gold door.

**BODY:** Colors lighter than Colonial shades: blue, beige, light yellow, pale green. **TRIM:** Dark green, red, brown, black, off-white. Door dark green, medium blue, black, white, red. Porch color similar to body.

 Beige body, white trim, black shutters.

**BODY:** Shades of white, pale pink, yellow, blue, gray. **TRIM:** White trim with white siding; for non-white siding: gray/blue, olive green, buff, dark bottle green, black trim. Shutters in green. Doors in dark green, medium blue, black, natural. Porch color similar to body.

 White or yellow body, white trim, dark green shutters.

**BODY:** Colors of stone, moss, and grass, like pale gray, olive, mossy greens, tan, ocher, fawn, straw, mustard. **TRIM:** Same color as body but in a contrasting shade, darker than base color when light, lighter than base color when dark, or in dark gray, dark green/brown, creamy off-white. Shutters in a deeper shade. Door in natural wood. Porch a shade lighter or darker than body.

 Light gray body, dark gray trim, grained door.

**BODY:** Medium colors: Light stone or earth shades; pale or deep gray, blue gray, mossy greens, tan, ocher, sand, buff. **TRIM:** Contrasting shade of body color; creamy off-white, sand, brown, olive, gray, green, gold; shutters in brown, red, black; sash in red-brown; doors in black, natural, burgundy. Porch a shade lighter or darker than body.

 Pale beige body, darker beige trim, black door.

 Golden sand body, lighter sand trim, natural door.

**BODY:** Medium colors, warm earth tones; dark green, brown, red, gold, gray, maroon, ocher, olive, pumpkin, rose, taupe. **TRIM:** Dark body w/ light trim or light body w/ dark trim of same color. Trim darker shade than porch, in maroon, brown, gray, green, yellow; shutters in green, red, blue; door varnished or grained. Porch in harmonious, darker shade than body.

 Light olive body, dark olive trim, red accent.

 Deep rose body, olive trim, deep olive accent.

**BODY:** Shades of white, pale blue, yellow, gray, cream, tan. **TRIM:** Lighter than body: White and off-white trim, ivory, cream; door varnished or grained. White porch.

 White body, dark green trim & shutters.

 Tan body, white trim.

**BODY:** Stained shingles. **TRIM:** Shades of white, gray.

 Silver-gray stained shingles, gray-white trim, green shutters.

**BODY:** Olive, rust, brown, gray, gray-blue. **TRIM:** Lighter than body: White, pale gray, ivory. Porch color similar to body.

 Olive body, olive-gray trim, natural door.

**BODY:** Brown, green, gold; stained shingles. **TRIM:** Contrasting to body: Dark reds, browns; or light yellow, gray, green or white; door varnished. Porch color similar to body.

 Brown body, pale yellow trim, natural door.

# COLORS

## STYLE (Period): Color Range for Body

**COLONIAL PERIOD (1780-1860):** Neutral, muted body colors. (Colors were limited by technology.)

**FEDERAL (1780-1840):** Neutral, muted body colors.

**GREEK REVIVAL (1820-1860):** Light colors or white for the body, to imitate the marble of Greek temples.

**GOthic REVIVAL (1830-1880):** Body colors in earth tones to blend with landscape, in stark contrast to the white of the Greek Revival.

**ITALIANATE AND SECOND EMPIRE (1840-1855):** Earth tones for body color on early houses, more vibrant colors and greater contrast later.

**QUEEN ANNE (1870-1910):** Deeper colors emphasize mass and variety for the body. Many more colors available at this time.

**COLONIAL REVIVAL (after 1880):** Light colors for the body.

**SHINGLE (1890-1910):** Muted natural tones, gray shades for the body.

**AMERICAN FOURSQUARE (after 1900):** Natural colors for the body.

**BUNGALOW (after 1900):** Dark, natural shades for the body.

# REPAINTING

## Deciding When to Paint

### You DON'T Need to Paint If:

- There is no peeling, blistering, flaking, or chipping.
- The building is only dirty.
- The color is only fading.
- A color change is all that is wanted. (Excessive layering is a primary cause of failure.)
- Your stone, brick or stucco building has never been painted. (Painting can damage these buildings.)

### You DO Need to Paint If:

- There is excessive peeling or other paint failure (but consider touch-up, if failure is contained in a small area). If the paint is thicker than 1/16 of an inch (approximately 16-30 layers), the paint should be removed down to the bare wood. See the **Paint Problems and Causes** table in the Appendix for more information.
- If wood is bare. (Exposed wood should never be left unpainted.)

### Did You Know?

Many old masonry buildings in Gettysburg are made of soft bricks that were meant to be painted. Some were painted to hide poor quality brick or stone. Removing the paint from these buildings would drastically change their character and cause the bricks to erode. If you are unsure whether or not your building should be painted, call the Historic Preservation Officer at 334-1160 for help.

### Remember:

Paint only the parts of the building that need to be painted. Don't paint if the existing paint is in good condition. If the trim is the only part showing signs of wear, paint only the trim.

## WHY YOUR BUILDING WON'T "HOLD PAINT"

If you find yourself repainting your building more frequently than every 5 to 8 years, one of the following reasons may be to blame:

- There is too much moisture present.
- Your paint was applied under adverse conditions.
- Your paint was applied with inadequate surface preparation.
- There may be latex paint over oil base paints.

### EXCESS MOISTURE

Beginning in the 1940s and 1950s new construction materials, moisture-generating appliances, improperly installed insulation, and the abandonment of lead-based paint, made it more difficult to achieve a long-lasting paint job on wood siding. Periods of minimal maintenance compound the problem. Check the locations of your paint failure against the list below, and consider making the appropriate repairs to eliminate excessive moisture.



Peeling paint in Gettysburg.

### IF FAILING PAINT IS LOCATED NEAR THE ROOF LINE:

- Maintain all roof covering materials, gutters, and flashing.
- Cap unused chimneys.

### IF FAILING PAINT IS LOCATED BELOW WINDOWS:

- Clear weep holes of storm windows. Maintain sills and caulking.
- Position window air conditioners so that water does not stream down the side of the building.

### IF FAILING PAINT IS LOCATED OUTSIDE OF BATHROOMS, KITCHENS, OR LAUNDRY ROOMS:

- Keep relative humidity below 40% inside your home. Consider installing a dehumidifier if necessary.
- Ventilate bathrooms, kitchens, laundry rooms and clothes dryers to the exterior of the house.

### IF FAILING PAINT IS LOCATED NEAR THE GROUND:

- Move shrubbery that is too close to the house.
- Be sure that wood does not come in contact with the soil.
- Be sure that all ground and walkways are sloped away from your building. Be sure that downspouts and splash blocks are positioned to carry water **away** from the building.
- Consider damp proof courses and below grade waterproofing with the assistance of a trained professional.

IF FAILING PAINT IS NOT CONCENTRATED IN ANY SINGLE LOCATION:

- Properly treat all wood or masonry.
- Maintain all surface coatings on wood elements.
- Regularly inspect and maintain all mortar joints.
- Keep relative humidity below 40% inside your home. Consider installing a dehumidifier if necessary.
- Avoid making your house completely airtight.
- If walls or attics have been insulated, check to be sure that an effective vapor barrier was installed.

## PROPER CONDITIONS FOR PAINTING

### TEMPERATURE AND WEATHER

Weather conditions can dramatically affect your paint job. Paint should be applied when the temperature is between 50 and 90 degrees, and at relative humidity levels below 60%. Painting in direct sunlight can also ruin a paint job; it is best to paint in the shade. Always paint strictly according to the manufacturer's directions.

### SURFACE PREPARATION

If excess moisture or weather conditions are not causing your paint to fail, your surface may not have been properly prepared. The surface must be clean and free of loose paint. Harsh or abrasive methods should never be used to clean the surface or to remove the paint. Such methods involve considerable risk because they can remove the outermost surface of the material, speeding future deterioration, and they can destroy delicate detailing.

### AVOID USING THESE ABRASIVE METHODS:

- Pressure washers
- Rotary grinders
- Open flame torches
- Sandblasting
- Chemical stripping

### USE THESE METHODS INSTEAD:

- Hand cleaning
- Light hand sanding
- Hand scraping

*See the Paint Problems and Causes Table in the Appendix for more detailed information.*

### TIPS FOR PREPARING A SURFACE FOR PAINT:

- Only paint a clean surface. Use household detergent, water, and a natural bristle brush.
- After cleaning, always dry, treat, and prime all surfaces before repainting.
- Wood that is very dry may not accept paint well. An application of boiled linseed oil, cut 50% with paint thinner or turpentine, can condition the surface for painting with an oil-base primer.
- New cedar clapboards may require a light sanding prior to painting.
- If preparation involves lead-based paint, call the National Lead Information Clearinghouse at 800-424-LEAD.

# REPAINTING

## Before you Repaint, Look at Your Paint and Ask These Questions:

1. What kind of paint failure is evident? (Is it peeling, blistering, or chipping?)
2. Where is the paint failure? (Is it under the roofline, or is it outside the bathroom?)
3. How has paint been applied in the past? (Infrequently, with poor quality products, or on the hottest day of the year?)

Answers to these questions can help you determine the cause of paint failure and help your next paint job last longer.

### Remember:

Only after thoroughly inspecting all the painted elements of the exterior of your building, and identifying each paint surface condition and cause of deterioration, can an appropriate program be developed to remedy exterior paint problems.

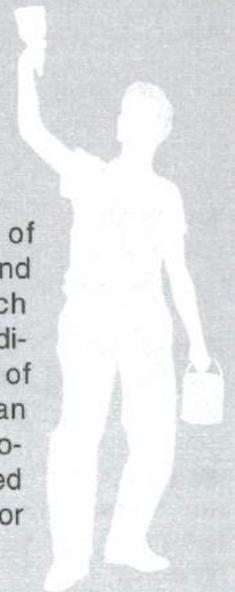

# REPAINTING

## Removing Paint

### When Should ALL Layers of Paint Be Removed From Wood?

- When painted exterior wood surfaces display continuous patterns of deep cracks.
- When extensive blistering and peeling reveal bare wood.
- When windows, shutters, or doors have been “painted shut.”
- When new wood is being pieced in and a smooth transition is required.



Peeling paint in Gettysburg.

### When Should ALL Layers of Paint be Removed from Masonry?

- If a masonry building was not painted historically, **and** if the paint is damaging the building.

#### Guideline:

Remove paint from historically painted surfaces only to prevent deterioration.

#### Remember:

Remove deteriorated paint to the next sound layer using the gentlest means possible.

#### Warning:

Any method that can remove paint can harm you and your building if not used properly.

## OIL OR LATEX?

### What's the Difference?

Oil paints have a linseed oil base that penetrates the surface of wood and seals it against moisture. Modern oil-based paints generally have a much lower linseed oil content than historic paints. Alkyd resins have replaced the oil in these cases. Preservative, penetration, adherence, and durability qualities are generally better with oil paints, but they are harder to clean up than latex. Oil paint is the type found on most historic houses; until about 1970 it was the only paint used.

**Latex** is a modern paint that is water based. It is less durable, easier to apply, and easier to clean up than oil. Recent manufacturing techniques are improving these paints. Latex breathes more than oil and allows moisture in masonry to escape; however, it exerts more tension on the underlying surface and can pull underlying layers of oil paint away from the wood.

### Which Should I Use?

- Oil over latex can lead to serious problems. Opt for oil over oil and latex over latex; however, environmental regulations may complicate this rule. If changing from oil to latex becomes necessary, see below.
- If you paint latex over oil, completely prime the old surface with an oil primer that is compatible with your top coat of latex. The oil primer will bond to the old surface and provide a new, flat surface for your latex. If you must use a latex primer over the oil, be certain that all dirt, chalk, and gloss are removed from the old surface before beginning.
- Once you use latex, you can't go back to oil without removing all layers of paint down to the bare wood.
- Oil paints are good for hard-use items.

## CLEAR FINISHES AND STAINS

Clear finishes and stains are not appropriate for wood surfaces that were historically painted. New wooden elements added to historic buildings, such as replacement porches, should always be painted. Shingles that were historically stained, such as those on upper stories of bungalows, should not be painted. Pressure treated lumber should be painted after weathering approximately one year. Avoid using sealers or waterproof coatings on masonry walls; they have been found to speed masonry deterioration and increase moisture problems. If paint must be used to protect damaged masonry (for example, brick damaged by abrasive cleaning), use only vapor permeable (breathable) masonry paints.

#### For more information see these sections:

- Paint Problems and Causes table in the Appendix.
- Masonry Walls.
- Wood Walls.
- Water and Your Building in the Maintenance chapter.



The first block of York Street around 1926.  
Photo courtesy of Gettysburg National Military Park.

# COMMERCIAL BUILDINGS & SIGNS







Commercial buildings on the south side of York Street.



Commercial buildings on the east side of Baltimore Street.



Commercial buildings on the north side of Chambersburg Street.

## COMMERCIAL BUILDINGS AND SIGNS

The commercial district of Gettysburg today is composed of buildings originally constructed for commercial purposes or for a combination of commercial and residential uses, and buildings originally constructed as residences that were later converted to commercial use. Because these buildings have different origins, they may require varying treatments. However, careful coordination of all these buildings can enhance the appearance of the business district, draw customers to the area, and make Gettysburg a better place for residents and visitors to live, work, and shop.

Because many of the commercial buildings in Gettysburg are so closely spaced along the street, the facades — or front walls — of the buildings are particularly important. Alterations to the facades must be carefully considered to ensure that the special character of the building is maintained.

# COMMERCIAL BUILDINGS

## Gettysburg Storefronts



The storefront (4a) at 159 North Washington Street.



The storefront (4b) at 101 Chambersburg Street.



The storefront (4b) at 343 South Washington Street.

## GETTYSBURG'S COMMERCIAL BUILDINGS

Gettysburg's commercial buildings are typically three stories in height and are divided horizontally into three parts:

1. A storefront at the bottom,
2. A middle section comprised mainly of windows, and
3. A decorative cornice at the top.

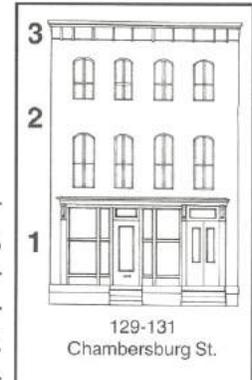

Although these three parts are usually distinct, the building typically displays a single, harmonious design. This harmony is often achieved through the consistent placement of windows one above the other. Materials and details may increase this coordinated appearance. Retaining this three-part division and the characteristic elements of each part is important for maintaining the character of both the building and the overall district.

### 1 The Bottom of a Commercial Building -- The Storefront

The lowest part of a commercial building, whether originally erected for residential or commercial purposes, includes the entrance to the business, windows to display merchandise, and associated structural and ornamental features. Some converted residential buildings might only receive enlarged windows, but many such structures in Gettysburg have had storefronts installed.

The storefront is often the most significant feature of a commercial building. For this reason, it should be carefully maintained. For the same reason, it has historically been a prime target for alterations. Because storefronts are highly visible, sensitive design and rehabilitation can help draw customers into a business establishment. Such rehab is also a clear sign that the downtown is an active place, and this, too, will encourage consumers to shop downtown.

The storefront is the most common form for the combination of entrance and display elements in buildings. Its primary characteristic is its open quality; a storefront typically has more glass than solid materials. Historic storefronts may be constructed of metal (cast iron, bronze, copper, tin, galvanized sheet iron, cast zinc, stainless steel), wood, masonry, or pigmented structural glass. Later alterations may have added plastic, imitation brick or stone, wood products, or new glass to the storefront. The typical, character defining features of a storefront are identified on the next page.

## Parts of a Storefront

- 1. Bulkheads** (or kickplates). Bulkheads provide a base for the glass of the display windows. They are typically of frame construction, and sometimes have raised panels.
- 2. Display windows.** Extensive window displays were considered advertisements in themselves and visibility of merchandise was a priority for most shop owners. Large display windows typically flank the entrance in a storefront.
- 3. Structural supports.** Constructed of wood, masonry, or cast iron, these supports are necessary to carry the weight of the structure above and to allow the use of large display windows. These supports are typically located on both sides of the windows and entrance doors.
- 4. Entrance.** Storefront entrances are either set flush with the windows and wall (4a), or are recessed (4b) to provide more display area. (See the photos on the opposite page.) Sometimes a secondary entrance that leads to the upper stories is incorporated into the storefront design (4c). (See below.) Remaining historic wooden doors are important and should be retained.
- 5. Transoms.** Transoms are windows typically located above the entrance and the display windows. They are often of multipane design, or fitted with stained, leaded, or textured glass. Sometimes they incorporate lettering or ornamental designs.
- 6. Storefront Cornice.** A cornice (a simple or elaborate series of moldings) usually caps the storefront composition. It may include brackets, panels, and other ornamental details.
- 7. Other Elements.** Storefronts also typically include signs and awnings, and may incorporate steps and ramps into their designs.

## The Parts of a Storefront



The storefront at 129-131 Chambersburg Street.

# COMMERCIAL BUILDINGS

## Parts of a Storefront

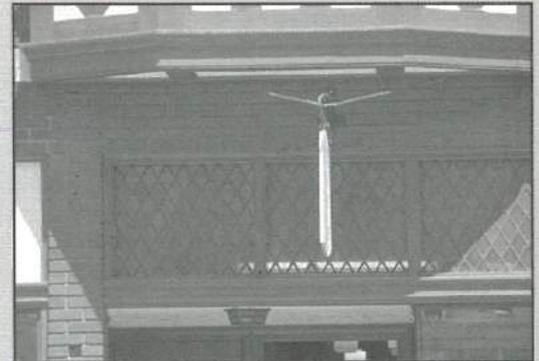

A leaded glass transom at 25 Chambersburg Street.



A bulkhead at 58 Chambersburg Street.



The storefront at 129-131 Chambersburg Street.

# COMMERCIAL BUILDINGS



The middle of 129-131 Chambersburg Street.



The middle of the Scharf-Bigham Building on Lincoln Square.



The top of 129-131 Chambersburg Street.



The top of the Scharf-Bigham Building on Lincoln Sq.

## 2 The Middle of the Commercial Building

Buildings erected for commercial or business purposes usually have two or three stories that comprise their middle section. A common characteristic of these buildings is the solid quality of this middle section, especially in comparison to the first story; this area usually has more solid wall and less glass than the storefront level below. The primary architectural feature of the middle section is usually a series of regularly spaced windows. The rhythm of this spacing helps create a harmonious design, and it makes the streetscape more interesting. The windows of the midsection may have decorative moldings, sills, hoods, or shutters, and decorative stringcourses or other ornament may be added between stories.

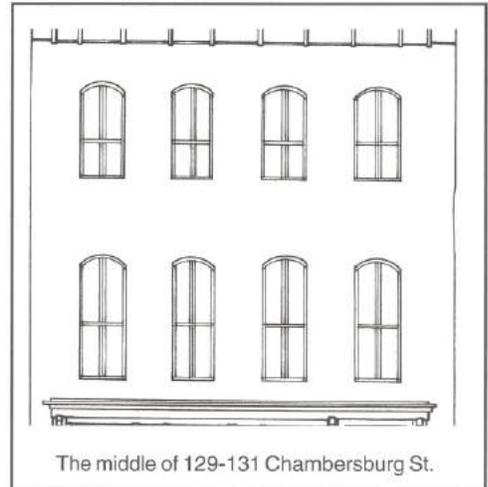

The middle of 129-131 Chambersburg St.

Residential buildings converted to business use may only have one story above the storefront level. In these buildings the second story has a residential appearance and scale. In some cases, the size of the window openings has been changed and the removal of detailing has destroyed this residential character. If the residential appearance remains, it should be retained.

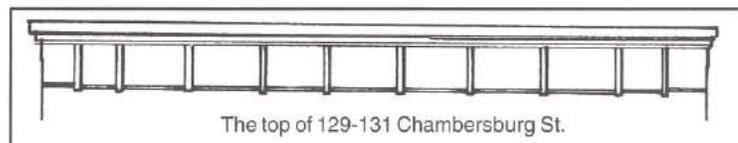

The top of 129-131 Chambersburg St.

## 3 The Upper Part — The Cornice

The top of a commercial building, as viewed from the street below, is usually composed of a cornice — a series of projecting moldings. (The actual roof of the building is usually not visible from the street.) The rooftop cornice caps the entire building design. Wood, sheet metal, cast iron, and corbelled brick (bricks that are stepped progressively forward and combined in a series) are all used to form rooftop cornices. Cornices may also incorporate panels, brackets, and a variety of ornament, and many cornices project a considerable distance from the wall. Because they are designed as an integral part of the overall building composition, cornices are important defining elements of commercial buildings.

The top portions of residential buildings that have been converted to business use vary considerably from the standard commercial cornice. Typically, a pitched roof remains visible, and a smaller, simpler wood cornice marks the top edge of the wall, although brackets and other ornament can be found.

# REPAIRING AND REHABILITATING STOREFRONTS

The repair and rehabilitation of a storefront can have a dramatic effect on the appearance of a building and on the number of customers who visit the building. The deterioration of individual elements of the storefront does not necessarily require the replacement of the entire storefront. Follow the options below to determine the appropriate treatment for a deteriorated storefront.

## OPTIONS

- 1 FIRST CHOICE:** If moderate deterioration has occurred, repair damaged portions in place and replace deteriorated parts with matching material.
- 2 SECOND CHOICE:** If a major portion of the storefront has deteriorated to a point beyond repair, salvage individual elements. Reproduce the historic storefront using the salvaged elements and new elements of the same material modeled on those salvaged.

The storefront of 13 Chambersburg Street under renovation.



- 3 THIRD CHOICE:** If the storefront is deteriorated beyond repair, and elements cannot be salvaged and/or an accurate restoration in the same materials is not possible, undertake a simplified design that conveys the same visual characteristics as the original. Key elements to duplicate include the overall composition, size, location, and spacing of elements, as well as the character of openness achieved from the amount of window glass. Substitute materials that convey the same visual characteristics as the original material may be considered.
- 4 FOURTH CHOICE:** If no evidence of the historic storefront remains, undertake a contemporary design that retains the commercial character of the building, and is coordinated with the spacing of elements in the wall above. Elaborate recreations should not be undertaken without accurate documentation.

# COMMERCIAL BUILDINGS

## Guidelines for Rehabilitating Existing Storefronts

- Maintain the commercial character of the storefront. Avoid adding elements that appear residential in character.
- Maintain the open character of the storefront that is achieved by using comparatively large amounts of glass. If a smaller window area is desired for a new use, retain the historic windows and install interior blinds, shutters, or curtains. Don't add solid materials to display window openings.



The new storefront at 13 Chambersburg Street.

- Use materials that were used historically. Because of the high visibility of storefronts, vinyl and aluminum siding, artificial masonry, and mirrored or tinted glass are not appropriate.
- Historically, storefronts were set into the facade — not applied to it. This character should be maintained.
- Maintain the location of the historic storefront entrance. If the entrance was always at the center of the building, avoid moving it to the side.
- Avoid placing air conditioners in storefront transom windows.

# COMMERCIAL BUILDINGS

## Awning Guidelines for Commercial Buildings

*Awnings have a number of advantages for commercial buildings. They help control heat gain in the summer, shelter customers, provide space for a sign, and add visual interest to the building.*

- Choose retractable awnings. They can be opened and closed as weather and light change.
- Install awnings over entrances, large first story windows, and possibly over individual windows on upper stories of commercial buildings. On a storefront, they may be installed below the transoms or below the storefront cornice.
- New awnings should be of canvas or natural, flexible fabrics. Plastic, metal and wood awnings reinforce the hard lines of the building, and the rigid character of the material does not allow flexibility in heating and in cooling.
- Install awnings without damaging materials or hiding important features.
- Awnings should have angled profiles unless the opening is arched.
- The awning should not exceed the size required to simply cover the window or protect the entrance. An awning should not span solid wall areas.
- Lettering may appear on the lower flap or on the awning sides. It should be scaled to the size of the awning and should be compatible with other signs on the building.
- For awnings on residential buildings, see the chapter on windows and doors in this guide.



27 1/2 Chambersburg St.

## GUIDELINES FOR UPPER STORIES AND CORNICES OF COMMERCIAL BUILDINGS

- Maintain the rhythm created by upper story windows. Avoid filling in window openings, adding new openings, or otherwise altering their shape or size.
- Closed window openings should be reopened and treated as original.
- Place air conditioning units on walls that are not visible from the street. Avoid creating openings in the front wall to accommodate through-wall air conditioners.
- Retain and maintain all window moldings and trim, and other elements of the midsection of commercial buildings.
- Retain and maintain all rooftop cornices, brackets, and other related features and details.
- If a historic cornice must be removed because it is too severely deteriorated, replace it with a new cornice. The new cornice may be of a simplified design, but it should convey the same character as the historic cornice. Never remove a cornice without replacing it.



48-52 York Street.

## DETERMINING THE HISTORIC APPEARANCE OF YOUR COMMERCIAL BUILDING

- Later storefronts often hide rather than remove original elements and details. If you are seriously considering restoration, consider carefully removing select non-historic materials. This may assist in revealing the historic character of the storefront. If historic elements are revealed, they should be retained and incorporated into restored storefronts.
- Look for old photographs.
- Ask your neighbors.
- Look for old materials stored in the basement or attic.

## GUIDELINES FOR REPLACEMENT STOREFRONTS

- Maintain the cornice height of the historic storefront and the location of the storefront and secondary entrances when designing new storefronts.
- Use materials that were used for historic storefronts, including wood, cast iron, and transparent glass.
- Create a design of scale, massing, and size appropriate to the overall building and the surrounding streetscape.
- Simplify graphics, awnings, and detailing to contribute to streetscape compatibility.



17 Chambersburg Street.

### Priorities for Gettysburg

- Remaining historic storefronts should be maintained and repaired, not replaced.
- Storefronts that have been altered or replaced should be restored to their historic appearance.
- Retain original designs and dimensions of recessed entrances.
- Maintain the historic size and shape of window openings of upper facades of commercial buildings. Re-open window and door openings that have been filled, and install appropriate doors and windows.
- Maintain all historic storefront cornices.



125-127 Chambersburg Street.

## COMMERCIAL BUILDINGS

### Guidelines for Residential Buildings Converted to Commercial Use

- Maintain the residential character of the building, particularly above the first story, by maintaining the historic size and shape of window openings, and the shape and character of the roof.



46 York Street.

- If the first story of the building remains residential in character, continue to maintain and retain that character.
- If the first story has been altered to incorporate a storefront, that storefront may now be historic and significant. Maintain and retain such elements.
- If unsympathetic alterations were made to incorporate a storefront at the first story, consider other options for making the building compatible with other buildings on the street, for example, through the use of appropriate awnings and signs.



34 and 38 York Street.

# SIGNS

## Guidelines for Historic Signs

- If a historic sign cannot be retained in its original location, consider moving it to a different exterior location (ensuring that the sign and the building are not damaged), or move the sign inside where the public can see it.
- If a historic sign cannot be retained, consider donating it to a museum, preservation group, or salvage yard.
- Coordinate new signs with existing historic signs by using compatible sizes, shapes, colors, lettering, and location.
- Make provisions for the protection of historic signs when the building is undergoing maintenance.



Part of the "Ice House".

## Historic signs are particularly important if:

- They are associated with historical figures, events, or places.
- They identify the history of the product, business, or service associated with the building, district, or area.
- They reflect the history or development of the building or the district.
- They are good examples or are characteristic of period signs or sign craftsmanship (i.e., gold leaf, neon, etc.).
- They are integral to the fabric of the building (i.e., Carrara glass, carved stone, tile floor, etc.).
- They are local landmarks.

# SIGNS

Signs are important parts of commercial buildings, both from a visual and a financial perspective. A clever, carefully designed sign can make a good first impression and can attract customers. A confusing, ordinary sign can detract from the appearance of a building and can turn customers away.

Signs were attached to and erected near buildings in Gettysburg from the earliest periods of the borough's settlement. Old photos show that sign shape, lettering, and location were some of the primary elements used to identify businesses and to attract customers. New signs advertising today's modern businesses can use these same elements to create contemporary signs that both enhance the character of the historic building and convey necessary information to the public.

The guidelines presented in this section are meant to help property owners design and select new signs that are compatible with their historic buildings and Gettysburg's historic commercial area, while meeting the needs of modern business. In addition to following the guidelines in this manual, all signs installed in the borough must meet the provisions of Gettysburg's Zoning Ordinance. For more information, call the Zoning Officer at 334-1160.

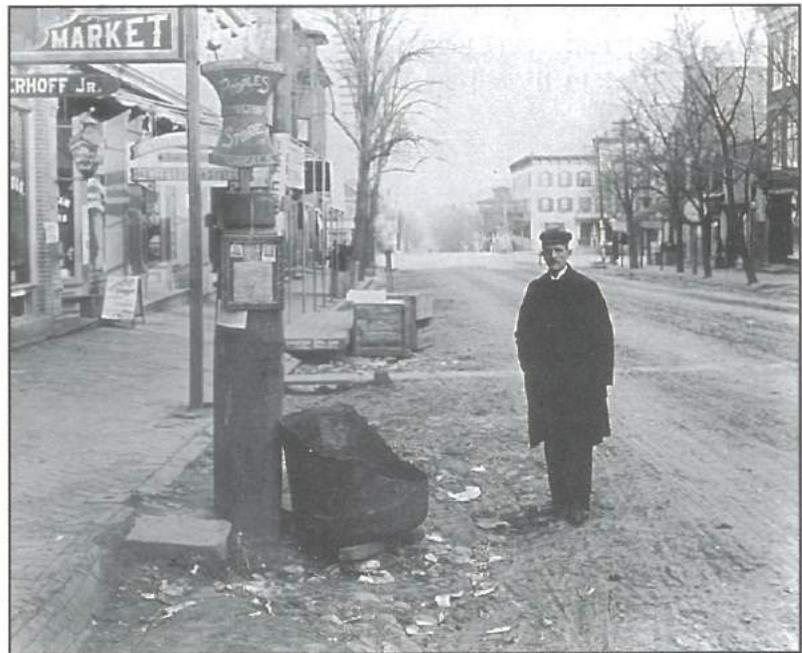

A view of the commercial buildings and signs on Baltimore Street, looking north towards the square around 1900. Photo courtesy of Gettysburg National Military Park.



## SIGN POSITION

The diagrams below identify the various appropriate locations for signs on buildings in Gettysburg. Locations are identified for buildings that were originally erected as commercial or business buildings, and for buildings that were originally built as houses but are now used for commercial purposes. Signs of every type pictured may not be appropriate for your building. The size and number of signs allowed are determined by the Gettysburg Zoning Ordinance.

### SIGNS FOR COMMERCIAL BUILDINGS

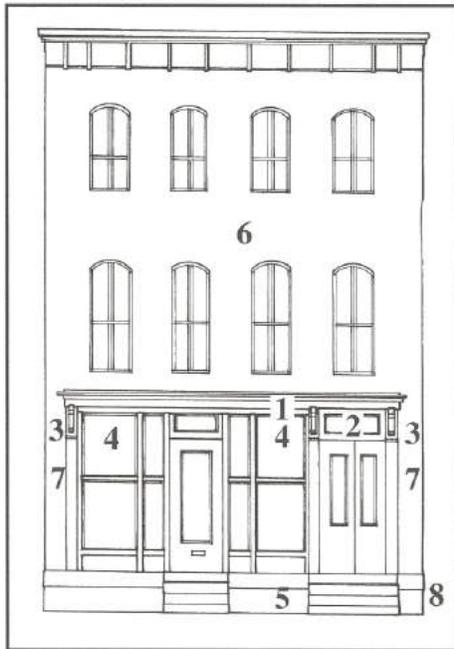

(1) Under storefront cornice; (2) hanging parallel to the front wall over a recessed entry; (3) hanging from a bracket perpendicular to front wall, below second story sill level; (4) paint, vinyl, or etching on window(s); (5) temporary, movable, freestanding sidewalk signs; (6) in some cases, painted on upper portions of masonry walls; (7) attached flush to the building; (8) freestanding or ground sign when space permits. (Signs may also appear on the lower flap of an awning.)

### SIGNS FOR RESIDENTIAL BUILDINGS



(1) hanging from a bracket perpendicular to front wall, below second story sill level; (2) on lower flap of fabric awning; (3) paint, vinyl, or etching on window(s); (4) temporary, movable, freestanding sidewalk signs; (5) attached flush to the building; (6) freestanding or ground sign when space permits

## SIGNS

### Guidelines for Attaching a Sign to a Building

The method of attaching signs to buildings must be carefully considered to minimize damage to historic materials.

- Choose methods that allow holes to be appropriately patched if the sign is removed. When possible, mount signs in mortar joints, not in masonry, so holes can be patched if the sign is removed.



A sign bracket at 21 Chambersburg Street.

- If holes or hardware remain in the building from previous signs, attempt to place the new sign in the same location.
- Place signs so that significant architectural details and features, including transom glass, remain visible.

# SIGN TYPES

**GROUND SIGNS:** Ground signs are not attached to a building or other object. They usually take the shape of rectangles and are located on lots with open land.



**FREE STANDING SIGNS:** A freestanding sign is typically hung from a horizontal rail that is attached to a vertical free-standing post.



## SIGNS IN GETTYSBURG

The photos on these two pages illustrate the most common types of signs used in Gettysburg today. A single building may accommodate more than one type of sign, but all signs on a single building should work together in a coordinated design.

**HANGING SIGNS:** Hanging signs are usually hung from an iron bracket perpendicular to the wall of a building, but parallel hanging signs may also be appropriate.



Parallel Hanging Sign

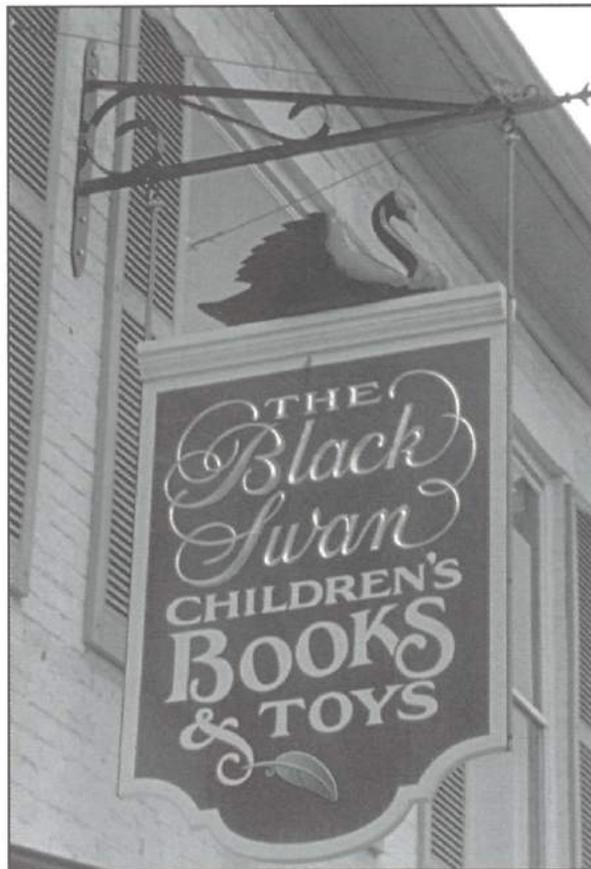

Perpendicular Hanging Sign

**Note: Painted wall signs** include any signs that are painted directly onto the surface of the wall. This type of sign was used historically, but is appropriate today in limited cases. See the first page of this section on signs for an illustration of a painted wall sign.

**WINDOW SIGNS:** Window signs include all signs that are attached in any way to a window. Painted signs, vinyl signs, and etched signs are the most typical types of window signs found in Gettysburg.



**AWNING AND CANOPY SIGNS:** Awnings and canopies can include lettering and graphics on the lower flap, or valance. Letters and ornamental elements can be painted, screened, or sewn on the fabric.

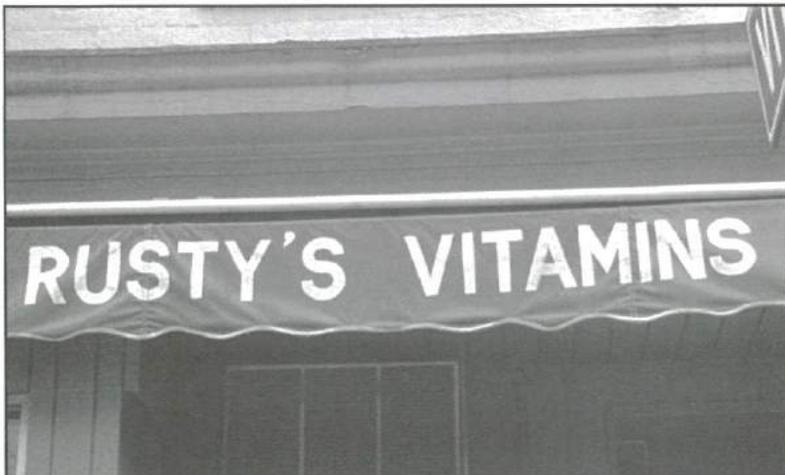

## SIGN TYPES



**FLUSH MOUNTED WALL SIGNS:** Flush mounted wall signs include all signs that are more or less flat and attached parallel to, and directly against, the face of the building.

**SANDWICH BOARDS:** Sandwich boards are two-sided, movable signs that are triangular in form. They may advertise information that changes regularly (such as menu items), but the temporary nature of the information does not mean that this type of sign should be considered makeshift. Sandwich boards should be designed as carefully as all other business signs.



# SIGN SHAPE

Simple geometric shapes are appropriate for most signs, buildings, and locations. They are recommended for signs that use large amounts of lettering.

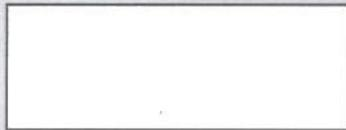

## SIGN SHAPE

Small flush mounted signs are best suited to simple shapes, although scrolled tops and shaped corners resembling shields (which were common in signs before 1860) may be appropriate.



For larger flush mounted signs, simple rectangles are best. Shaped corners and ends may also be appropriate.



Shapes that represent the type of business are encouraged for all sign types.

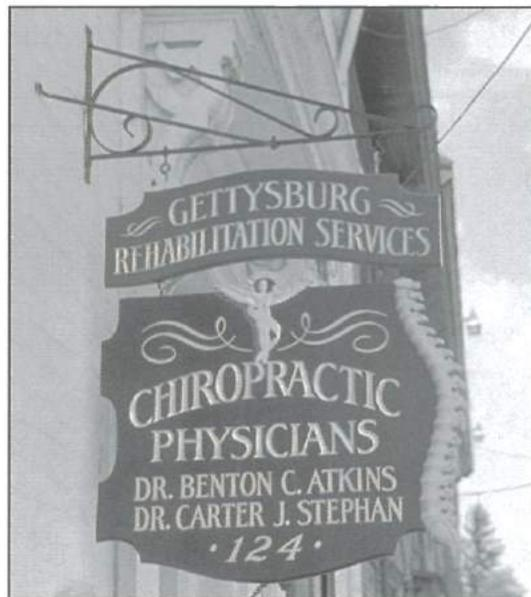

More ornamental shapes may be appropriate for hanging and free-standing signs that do not include a large amount of lettering.

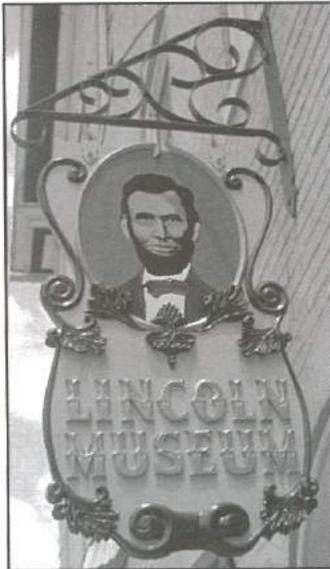

Window signs can use simple designs with horizontal lettering, or lettering can be set along simple curves. These signs can also incorporate graphics and logos of any shape.



Because ground signs are often larger in scale, simple shapes, generally rectangles, best convey their messages.



## SIGN SHAPE & SIZE

### Sign Size

Sign size is regulated by Gettysburg's Sign Ordinance. Signs should not appear out of scale with the building to which they are attached. They should not overpower adjacent structures or monopolize the streetscape. Because travel through the commercial areas of Gettysburg is by foot or slow-moving vehicle, signs need not be large to convey their message.

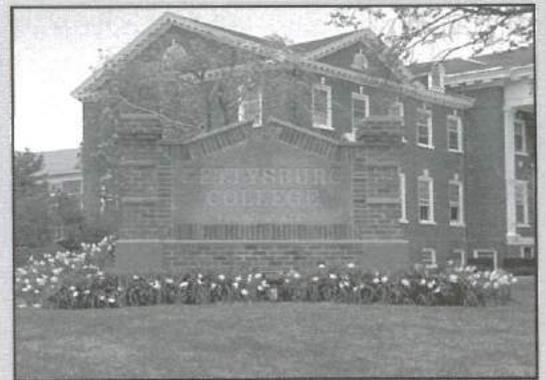

The size of this large ground sign is appropriate to the scale of the surrounding buildings and to the size of the site on which it sits.



The smaller size of the signs of this property are appropriate to the smaller building and the pedestrian scale of the surroundings.

# SIGNS

## Letter Treatment

*Regardless of the style of lettering used, the letters of a sign can be treated in a number of ways.*

- They can be individually shaped and attached to the sign, resulting in raised lettering, which adds texture and shadow to the sign. Individually carved or shaped letters were more common to signs that were created before 1860, than after that date.
- The letters can also be carved into the sign, resulting in recessed lettering, which also adds texture and shadow. Carved letters were used for signs throughout history.
- Letters can also be painted on the surface of the sign. Sign painters can use varying colors to suggest the shadows created by light shining on raised or recessed letters. Painted signs were used throughout history.



## Logos

If your business has a logo or a symbol that represents the type of business conducted within, try to incorporate it into your sign. This can increase the recognition of your business and help make your sign unique.

## LETTERING

The style of lettering used on a sign is important to overall design and clarity. The three main styles of lettering -- Serif, non-Serif, and script -- are illustrated below. Within these styles, numerous typefaces are available. Excessive lettering can confuse and overwhelm the reader. "Short and sweet" works best.

### Serif

Serif letters have cross strokes -- or feet -- at the tops, bottoms, and arms.

These are Serif letters.  
abcdefghijklmnopqrstuvwxy

### Non-Serif

Non-Serif letters (also called block letters) have no added strokes.

This is an example of Non-Serif lettering. abcdefghijklmnopqrstu

### Script

Script lettering resembles handwritten letters.

*This is an example of script lettering. abcdefghijklmnopqrst*

Different styles of letters were used during different time periods. If you are attempting to accurately reflect the time period of your building, you may want to follow these guidelines:

**SERIF** letters have been used throughout American history and were most common for signs erected until the early 20th century. Generally, simple Serif styles were used for signs created before 1860, and more elaborate Serif lettering was used for signs created after 1860. These later Victorian period signs often incorporated a number of letter styles into a single design.

**NON-SERIF** letters were not used until around 1920. At that time, designers considered the geometric shapes of this letter style more modern than the Serif style.

**Script** letters were not used as frequently as the other styles. Script lettering is more difficult to read and was used sparingly. If used for new signs, it should continue to be used sparingly. It is often successfully used for small, less important words, such as *of*, *at*, and *in*.

## MATERIAL

**Historically**, signs were most often made of wood and were hung from wrought iron brackets. Brass plaques were also made and attached directly to the building. In the late nineteenth century tin, cast iron, and steel became available for signs. After 1920 steel, aluminum, and plastic became popular. Leaded glass signs also became popular at this time. Business names and other designs were incorporated into leaded and stained glass transoms that were installed above doors and display windows. Tile signs gained popularity in the 1930s. Names and designs were created in tile at the floor of an entrance to a commercial building or under the display windows.

**Today**, signs can be made from all of these materials. Real wood can be used, but redwood, which is the preferred species, is limited and therefore expensive. Wood look-alikes include urethane board and MDO board. **Urethane board** is a compressed and hardened foam that can be finished by any real-wood method, including painting, carving, and routing. **MDO board** is similar to plywood and is made specifically for signs. It is composed of six layers, with the grain running in opposite directions in consecutive layers, which guards against warping. (Regular plywood is prone to warping.) MDO board has an approximate life span of 7 years. Like urethane board, it can be painted, carved, and routed, but it is heavier and thinner.

**Vinyl** is used for signs to produce letters and graphics that are applied to windows, boards, or other surfaces. Vinyl lasts longer than paint and is easier to change. A special frosted vinyl is available; on glass, it gives the appearance of etching. Vinyl, with the appearance of gold leaf, is also available.

**Plastic** signs are widely used for commercial advertisement, but they are generally not appropriate for historic areas. Corrugated plastic and plexiglass are also not appropriate.

**Aluminum** with a baked enamel finish can also be used for signs. White is the most common color, but others are available. Vinyl or painted graphics are typically added to the surface.

**Brass** or other metal is sometimes used for small identification signs, markers, and plaques.

**Cast iron** is typically used for brackets and other hardware required to hang signs. Standard scroll brackets are available, but custom designs can be created. **Steel** is also sometimes used for hanging hardware. When it is used, it should be finished with a dark color to resemble cast iron.

**Gold leaf** is a historically appropriate finish for signs. It gives letters and graphics a sophisticated, polished appearance. An **Acid ink** is available to create the texture and appearance of etching on glass. **Sandblasting**, which is generally inappropriate for historic buildings, can be used on **new** signs to create special textures.

## SIGNS

**COLOR:** The contrast between the background of a sign and the lettering of the sign is the most significant factor in legibility. Simple designs with simple color schemes are most effective. Few signs require more than three colors to convey their message clearly. Bright or bold colors detract from the historical character of the building and overwhelm the reader. The colors of a sign do not need to match those of the building exactly, but they should complement it. If gold leaf will be used for lettering or graphics, a darker background works best. Consider dark blue, black, dark green, or maroon. Providing a thin band of contrasting color at the border of the sign also helps define the sign.

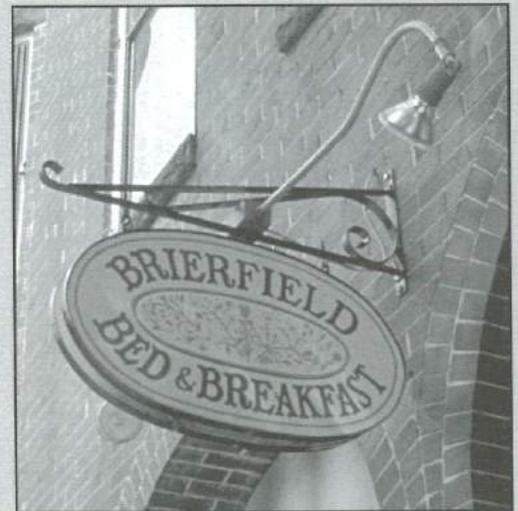

**ILLUMINATION:** If a sign requires illumination, the lighting should be indirect, hidden from view, and small in scale. Lights may be placed in the ground, pointing up at a sign, or for hanging signs, they may be attached to the bracket, pointing down. Internally lit signs are not appropriate for historic areas. Neon signs, which were made of slender glass tubes illuminated by electrified gas beginning in the 1920s, may be appropriate for a limited number of buildings. Existing neon signs can still be repaired and refurbished today.

# SIGNS

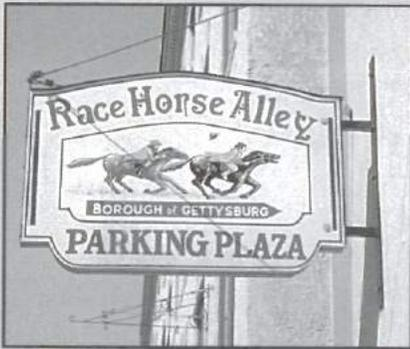

# SIGNS OF GETTYSBURG

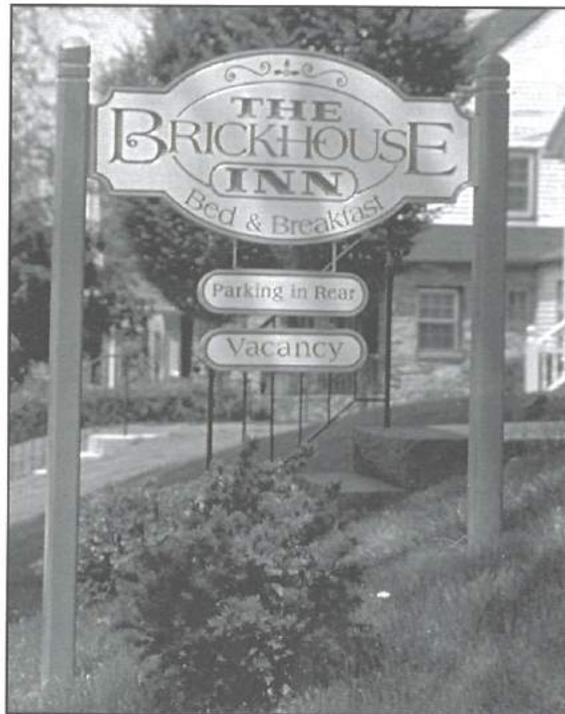
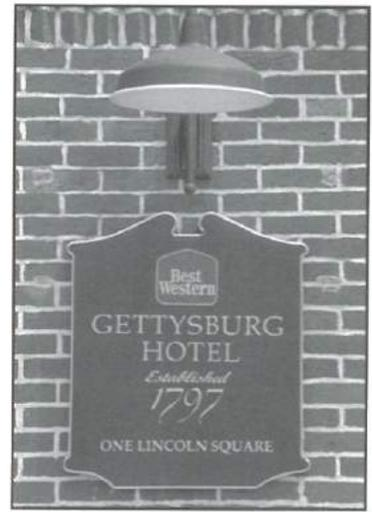
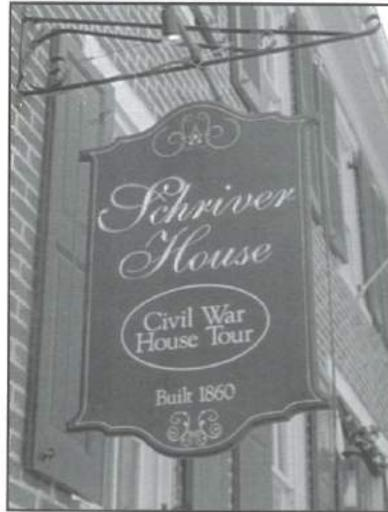



# OUTBUILDINGS, SITE & LANDSCAPING

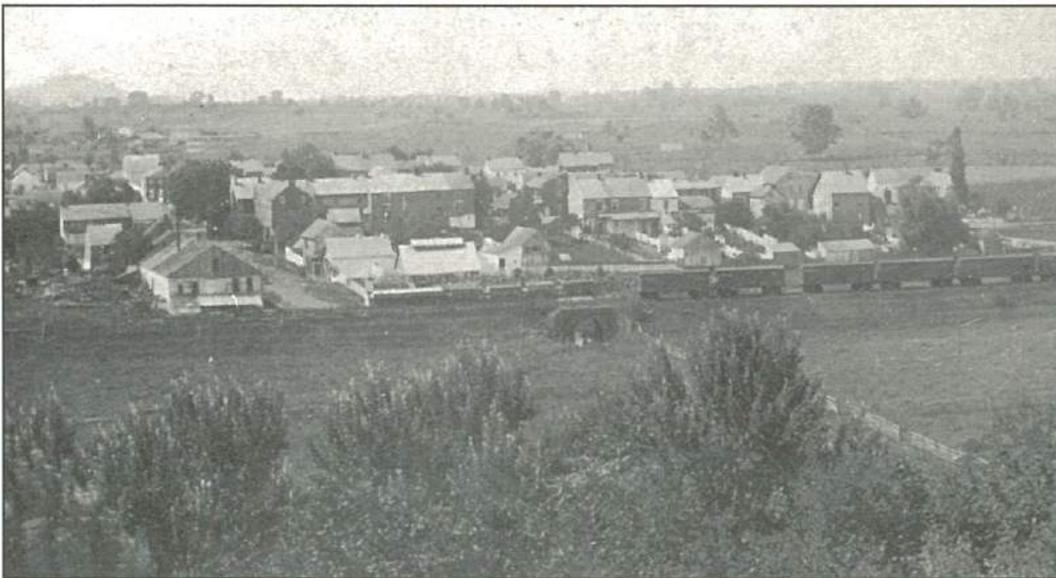

The rear of the north side of the 200 block of Chambersburg Street in 1910.  
Photo courtesy of the Borough of Gettysburg.



# OUTBUILDINGS, SITE, AND LANDSCAPING

Although most of a property owner's attention is typically focused on the residence or other main building on a site, secondary structures and site amenities often stand as part of a coordinated design that includes the entire building lot. The elements that surround a building are often essential to the character of the site and the neighborhood.

Secondary structures, or outbuildings, of a property may include barns, carriage houses, garages, summer kitchens, and sheds. Site amenities typically found on a historic property include fences and gates, driveways, walkways, landscaping, and retaining walls. Sometimes these elements are combined specifically to achieve a certain orientation or to maintain an important view. Retaining and maintaining these elements enhance a property's historic character.

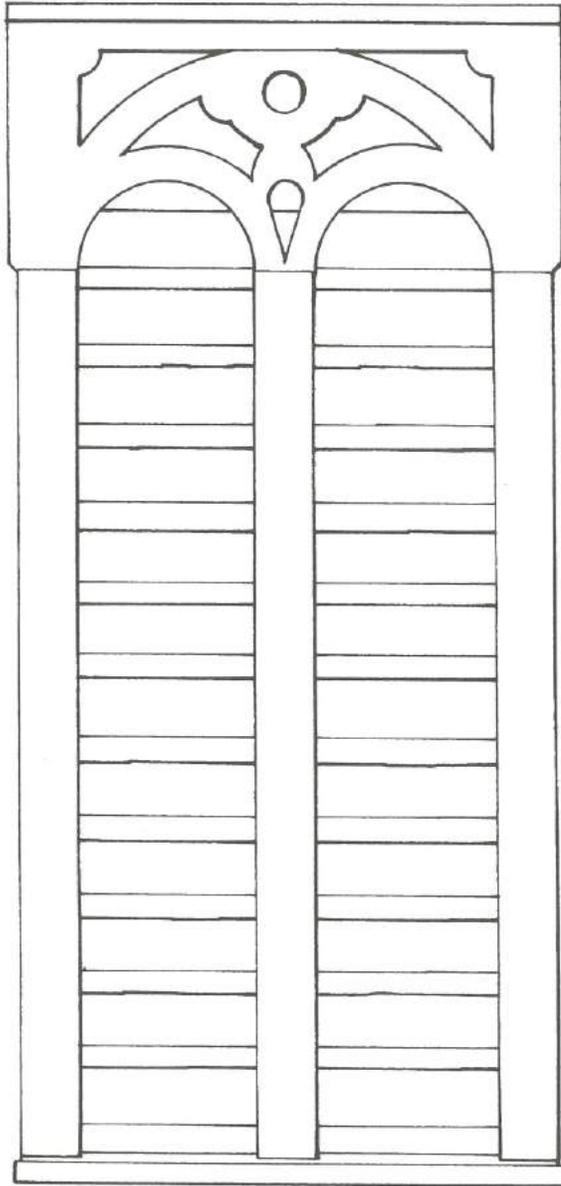

A louver on the outbuilding pictured at the right.

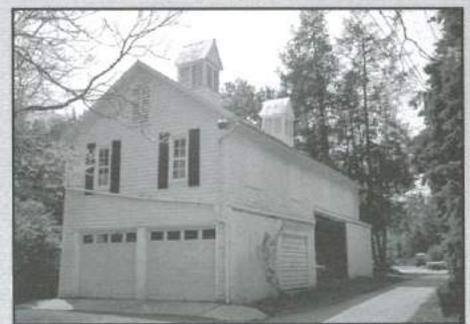

Two views of an outbuilding on Bikle Alley.

# OUTBUILDINGS

## Outbuildings are Significant if:

- The outbuilding dates to the original construction of the property.
- The outbuilding was constructed after the main building on the site, but was erected to house a function important to the use of the overall property, or if it illustrates an event or personage important to the overall property.
- The outbuilding is a good example of a style of architecture or method of construction, or if it incorporates distinctive characteristics of form, style, or detailing.
- The outbuilding possesses a strong relationship in form, style, detailing, use, or association with other structures or uses of the site.



An outbuilding on Bikle Alley.

## OUTBUILDINGS

Outbuildings that remain in Gettysburg contribute to our understanding of the borough's history and character. Many outbuildings reflect the style of the main building on the property. Well into the first half of the twentieth century, many garages were built with detailing to match the residence. Siding, brackets, ornament, rooftop structures, or even the overall shape of the structure, were duplicated to strengthen the relationship between the main building and the secondary building.

Outbuildings that date to the construction of the original property reflect an important part of the overall design concept for that property and should be retained. As some properties evolved over time, outbuildings were constructed to accommodate new uses. This practice illustrates the evolution of the property and such structures may also be significant.

## GUIDELINES FOR MAINTAINING OUTBUILDINGS

- Significant outbuildings should be treated as carefully as the main buildings they were meant to serve.
- All maintenance and repair issues that pertain to the main building on the site also apply to outbuildings.
- Significant details of outbuildings, such as multipane windows, louvers, rooftop elements (cupolas, weather vanes, cresting, etc.), doors (including pedestrian doors, overhead doors, sliding doors, etc.), wood siding, slate roofs, masonry walls and foundations, should not be overlooked.



A garage near the corner of Stratton and Middle Streets.

## REMOVING OUTBUILDINGS

Because outbuildings are often important components of the overall property, removing them from the site should be avoided. Property owners should consider the relationship between the outbuilding and other buildings and site elements, the view that will result from the removal of the building, and the overall condition of the outbuilding. If the outbuilding is a significant part of the property (see the previous page), demolition should only be considered if at least half of the structure is beyond repair. Prior to any demolition, contact the Historic Preservation Officer at 334-1160 and see the section on Demolition in this manual.

### OPTIONS

**1 FIRST CHOICE:** If the outbuilding is significant to the historic character of the property, it should be reinforced, repaired, and retained. Stabilization of the structure for potential use by later owners should be considered.

**2 SECOND CHOICE:** If more than one-half of the structure is too deteriorated to repair, including exterior siding, roofing material, structure, windows, and doors, and if the structure poses a threat to safety, these guidelines should be followed:

- The structure should be documented in photographs and drawings before demolition. The construction methods, materials, and details of the building, as well as the relationship between the outbuilding and other elements of the site, should all be included in the documentation.
- Steps should be taken to ensure that the demolition process will not damage other historic structures or features that remain on the site.
- Consideration should be given to re-using the disassembled materials for other appropriate construction projects (possibly for repairing parts of other buildings on site, if constructed of the same material), or to the disposal of the materials at an architectural salvage yard.

### GUIDELINES FOR NEW OUTBUILDINGS

- Because outbuildings were constructed to accommodate new uses as the main building and site evolved over time, new outbuildings for historic properties will be considered by the Gettysburg HARB.
- Historically, outbuildings were located at the rear of the main property, away from the main entrance and the important elevations of the main building. This practice should be continued for new outbuildings.
- Historically, outbuildings were designed to coordinate with the main building and other buildings on the site. This practice should continue for new outbuildings. New outbuildings should be simple in design and should coordinate with the main structures through the use of compatible building form, roof form, historic materials, and detailing.
- The construction of new outbuildings should be undertaken so that no damage is caused to other site elements.

## OUTBUILDINGS



A barn at the rear of 204 Carlisle Street.



A garage in Bikle Alley.



Garages and barns on Linbro Alley.

# SITE

## Guidelines for New Fences

- Simple designs are encouraged for new fences on historic properties.
- Generally, most historic fences were low and transparent. These characteristics should be duplicated in new fences visible from public streets and alleys.
- All fences should be of an appropriate scale in relation to the house.
- Simple wooden fences with vertical picket designs are preferred for properties whose main structure dates after 1850. Horizontal boards and split rails are generally not appropriate for the fronts of historic properties.

A variety of fences near 256 Baltimore Street.

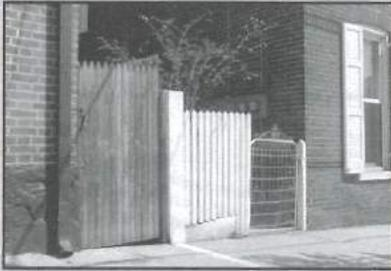

- Iron fences may be used for properties whose main structure dates after 1850.
- Elaborate fences should not be installed without clear photographic evidence that they existed previously.

A wrought iron fence on East Middle Street.



- Chain link is not appropriate for historic properties. It should not be used along streets, sidewalks, or property lines visible to the public. It may be acceptable at the rear of a property or at the sides of a property that are not visible from the public way. In these cases, the use of ivy, vines or other plant materials to cover or screen the chain link is encouraged.

## FENCES

Fences were first built for security. A securely built fence protected people and their possessions from predators — both animal and human. When security issues grew less demanding, fences were erected to mark property lines. They have been used traditionally as a barrier between the yard and the sidewalk, between the yard and the street, or between adjacent yards.

Early fences in Gettysburg were usually rough vertical boards, or post and rail, particularly along side and rear yards, or where a large part of the property bordered a road. By the mid-nineteenth century, some properties used a more finished wooden fence that incorporated pickets. Such fences gradually became more regular in construction and eventually incorporated pickets and gates of sawn designs. These fences continued to be used for years.

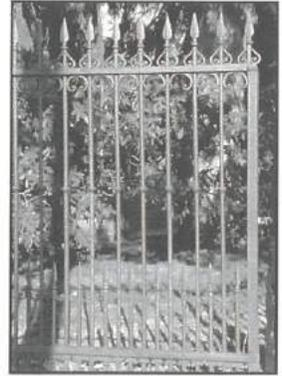

An iron fence at Evergreen Cemetery.

Cast iron fences became popular in the late nineteenth century. The nature of the material allowed extravagant, ornate designs. Wire fences (with wooden posts) were also used from the mid-nineteenth century. Wire allowed a certain level of ornamental design at a much more affordable cost, and was appropriate for more modest properties.

Wood, wire, and cast iron fences are still available today; their use is encouraged for historic properties. More recent fence materials, including chain link and vinyl, are not appropriate for historic properties because they have no historic character.

## GUIDELINES FOR FENCES AND HISTORIC PROPERTIES

- If historic fences remain on the property, they should be maintained and retained so that they may continue to enhance the historic character of the overall property.
- If portions of historic fencing are missing or beyond repair, new pieces that match the historic material should be installed.
- If an entire historic fence is beyond repair and must be replaced, the new fence should match the historic fence in material and detailing, although a new simplified design based on the historic design is acceptable.
- If a new fence is to be installed where one currently does not exist, the design of the new fence should be based on photographic documentation of a previously existing fence.
- If a new fence is to be installed where none currently exists and no historic documentation exists, the new fence design should be simple and should follow the guidelines in the sidebar at the left.
- Fences and grocers' alley gates should be retained and maintained.



Clipped hedges and a row of trees act as a fence on N. Washington Street.

## DRIVEWAYS, WALKWAYS, PAVING

Some historic properties include driveways, walkways, paths, and parking areas that were part of the overall design concept for the property. Most residential properties include a simple walkway to the front entrance and a driveway from the street to the side of the house or to a garage at the rear. In some cases, alleys give access to rear yards and parking areas, and driveways are not visible from the front yard. In urban areas where houses are closely built, small side alleys between houses, known as grocers' alleys in Gettysburg, provide a service entrance to the rear of the property. Because these pathways are typically less heavily used than most other routes, there is a greater chance that original paving materials, such as brick, may still remain.

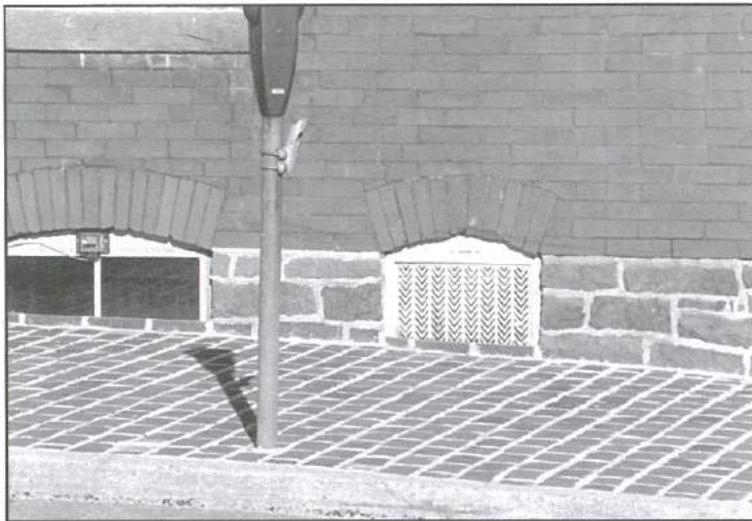

Brick paving near 304 Baltimore Street.

### GUIDELINES FOR EXISTING DRIVEWAYS, WALKWAYS, AND PAVING

- Existing driveways, walkways, paving, and related features that date to the original construction of the property or to later significant alterations should be retained and maintained.
- Existing driveway configurations should be maintained unless historic documentation indicates that a different configuration is more appropriate.
- If historic paving materials remain, they should continue to be retained and maintained. Consideration should be given to restoring the entire pathway to its original condition.
- Grocers' alleys should be maintained with their historic character. They should not be filled or blocked in any manner.

## SITE



Grocers' alley gate at 217-19 Baltimore Street.



Historic granite steps and wrought iron railings at 20 Chambersburg Street.



Brick paving at 404 Baltimore Street.

# SITE

## Parking Area Placement

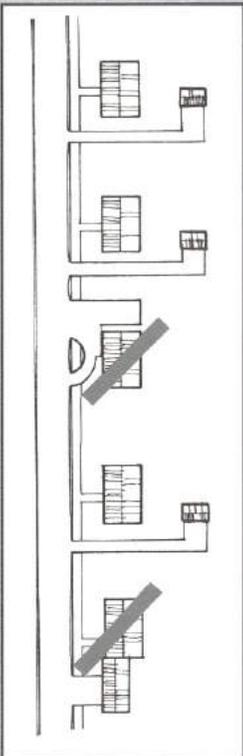

The placement of new parking areas should be compatible with the predominant placement on the block.

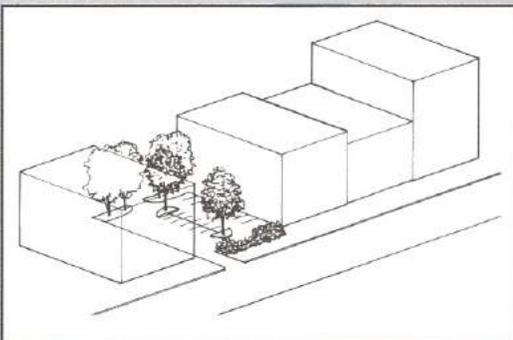

Parking lots should maintain the setback and use plantings to soften their appearance and increase compatibility.

## PARKING AREAS

### PLACEMENT GUIDELINES FOR NEW PARKING AREAS

The guidelines below can help make new parking areas more compatible with Gettysburg's historic district. All new parking areas must also conform to the requirements of Gettysburg's Zoning Ordinance. For more information on the Zoning Ordinance, contact the Borough's Zoning Officer at 334-1160.

If an additional parking area is required to accommodate a new use of a historic building, the HARB will consider the addition of a parking area according to the following guidelines:

- Parking lots should maintain the predominant setback on the street.
- Parking areas should not be constructed between the street and primary facades of buildings.
- Parking areas should be located on a portion of the site that is not readily visible from the public way or from important spaces within the building.
- The placement of parking areas should maintain important views to or from the site or the building.
- Parking areas should be located so that no significant site or landscaping features are destroyed, damaged, or otherwise negatively affected, and so that the historic relationships among elements on the site are not destroyed.
- Plantings, including trees and hedges, can be used to make parking areas more compatible with historic surroundings. Consider plantings along the edges of parking areas to shield the parking area from view and to maintain setback lines. Also consider plantings on islands within larger parking areas.



The row of trees along the side of this parking garage helps soften the structure's appearance and helps hide it from view.



An open parking lot at the corner of Liberty and East Middle Streets.

### GUIDELINES FOR EXISTING PARKING AREAS

- Existing parking areas should not be enlarged.
- If existing parking areas are placed in prominent locations on historic properties, they should be shielded from view with appropriate plantings.



## SITING, ORIENTATION AND VIEWS

Buildings, old and new, are typically located on a site with a specific orientation. Most buildings in Gettysburg are oriented so that the front entrance faces the main street. Other buildings are situated so that a specific view may be seen from a particular window, so that prevailing winds are blocked by trees, or so that the sun will warm a particular room. When orientation and siting were part of the original design concept for a building, these elements should be maintained. As alterations, additions, and construction projects are considered, the guidelines below should be followed.



No driveways are visible on this part of West Lincoln Avenue. Automobile access is provided at the rear of the property from Bikle Alley.



The driveway and rear entrance to a house from Bikle Alley.

### Guidelines for Siting, Orientation and Views

- Preserve the main entrance to a building if a new entrance must be added for a new use. Avoid removing doors and stairs, and avoid filling in the opening with new materials.
- New buildings should reflect the orientation of buildings in the neighborhood. For example, if all buildings on the street have main entrances on the front wall and automobile access from the alley, avoid constructing a new building with a driveway from the street leading to a side entrance.
- Alterations and additions should maintain the siting of the historic structure. For example, avoid constructing an addition that gives a building the appearance of being set at an angle to the street if all other buildings are set parallel to the street.
- When making alterations or building additions, maintain important views to and from the site.
- Alterations and additions should maintain an accurate sense of historical development for each individual property. Avoid adding elements that suggest that the property is older than it is. Avoid adding elements that are out of scale or otherwise inappropriate to the setting.

**NOTE:** FOR MORE INFORMATION on new buildings and additions, see the next chapter.

## SITE

### Siting and Orientation

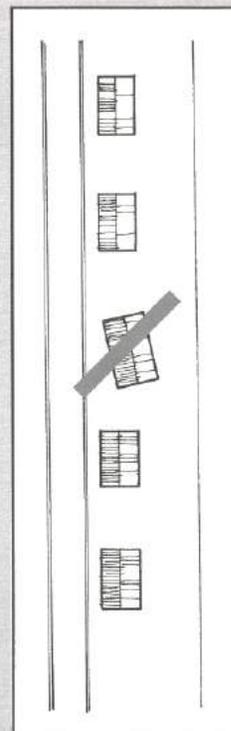

New buildings should reflect the predominant orientation of buildings in the neighborhood. Unusual orientations create a dramatic break in the historic streetscape.

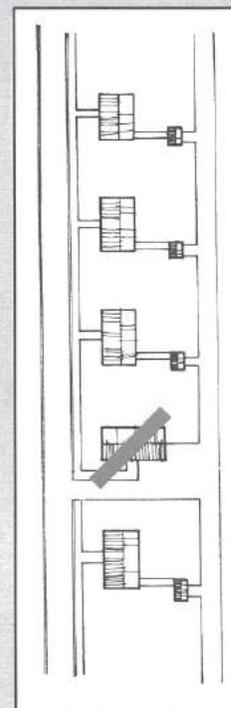

The proper placement of entrances and driveways can increase the compatibility between new buildings and existing buildings. Placing entrances and driveways in locations not represented on the street breaks the continuity of the streetscape.

# LANDSCAPING

## The Landscape Around Your Building

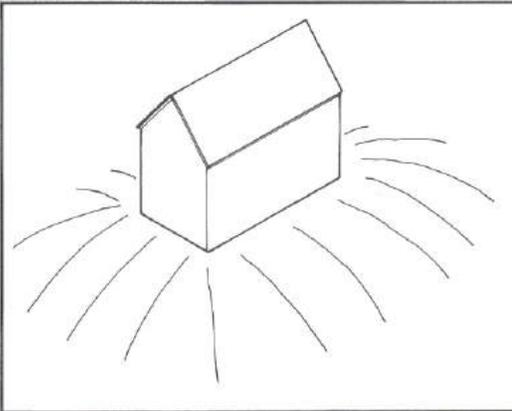

Make sure the ground slopes down and away from your foundation to ensure that water flows away from your building, not into it.

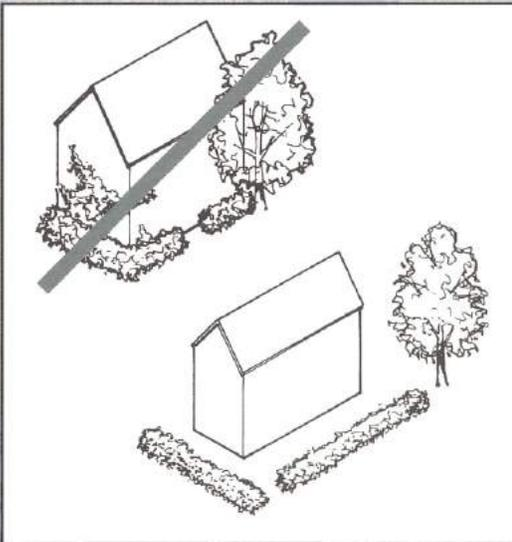

Avoid placing landscape elements too close to the foundation. They can encourage water retention, water damage, and plant growth on the building.

## LANDSCAPING

Landscaping features, including trees, shrubs, gardens, plantings, fields, and terracing, can contribute significantly to the overall appearance of a property. Some properties were landscaped at the time the buildings on the site were constructed. If historic landscaping materials are present, they should be retained. (See below.) If other prominent landscape elements are present, they should also be retained. These may include large trees, extensive plantings, and any other highly visible elements that have become recognized features in the streetscape or landscape. Gettysburg's HARB does not regulate landscaping, but the Borough's Zoning Ordinance does regulate retaining walls. For more information call the Borough's Zoning Officer at 334-1160.

### TO DETERMINE IF HISTORIC LANDSCAPING MATERIALS ARE PRESENT

- Look for unusual changes in texture or color of plant materials.
- Look for trees in rows or clumps.
- Look for exotic plants in unexpected locations, which may identify the location of an earlier planting bed.
- Check historic photographs.

### GUIDELINES FOR EXISTING LANDSCAPE ELEMENTS

- If historic landscape materials are present, retain and maintain them. Replace them in kind when necessary.
- Maintain existing trees whenever possible. Plant new trees to replace lost trees.
- Avoid removing landscape features without replacing them.
- Avoid relocating historic landscape features.

### GUIDELINES FOR NEW LANDSCAPE ELEMENTS

- Avoid radically changing the grade level of a site, especially when site drainage will be adversely affected.
- Place landscaping elements a sufficient distance from the foundation to avoid potential water damage.
- Water should be made to flow down and away from the building foundation.
- New landscape elements should not hide the walls of historic buildings or important architectural details.
- New retaining walls should be built with traditional masonry materials. Railroad ties and pressure-treated lumber are not appropriate if visible from a public street or alley.
- Plantings should be maintained regularly. Uncontrolled growth can damage historic materials.



Carlisle Street in 1910. Photo courtesy of Gettysburg National Military Park.

# UTILITIES & ACCESSIBILITY



## UTILITIES & ACCESSIBILITY

As time goes by, modern improvements, contemporary conveniences, and enlightened thought enhance our quality of life. They also affect our historic buildings.

Improvements in telecommunications, electric, gas, and water service, and in heating and air-conditioning have made living spaces much more comfortable year-round. However, these conveniences visually and physically alter structures and streetscapes with wiring and equipment.

Better and more widely distributed information has made us aware of the needs and requirements of persons with disabilities, and of their right to participate more fully in the experience of historic structures. This enlightenment presents us with the challenge of making our historic resources accessible without destroying the character that makes them special.



A cornice on Carlisle Street partially hidden by multiple cables.

# UTILITIES

## What to do with Dumpsters

- Dumpsters should be located at the rear of the building or on inconspicuous sides of the building.
- Dumpsters should not hide or damage significant historic features of the building, site, or landscape.
- Dumpsters should be placed in locations that are easily accessible to all users, including trucks, so that potential damage to the building is minimized.
- Living fences and wooden fences can be used to hide dumpsters.



Fenced mechanical equipment at the Bank of Hanover.



Mechanical equipment hidden behind a landscaped fence at the Gettysburg Hotel.



Lattice panels hide garbage cans on the alley behind East Stevens Street.

## UTILITIES

Because utility meter boxes, air handling units, and other service equipment are so common, the appropriate placement of these objects on historic buildings is often overlooked. Historically, service equipment was placed near the service entrance, which was located at the rear or side of the building. This placement on unobtrusive walls of buildings should be continued. There are three options for the placement of service equipment:

- 1) attached to wall,
- 2) placed on a roof, or
- 3) located on the ground.

Appropriate placement depends to a great extent on the type of equipment being installed; however, in all locations, the key to compatibility with historic resources is **concealment**.

### Methods of Concealment

- Locate equipment on rear or inconspicuous side walls.
- Plant vegetation to hide equipment on the ground or on the wall. Coordinate new vegetation with old.
- Erect appropriate fencing to shield equipment on the ground. Coordinate all fencing on the property.
- Paint wall-mounted equipment to blend with the wall.
- Set rooftop equipment back from the edge of the roof to reduce visibility from the street.

Additional guidelines for service equipment are listed below and on the following page.

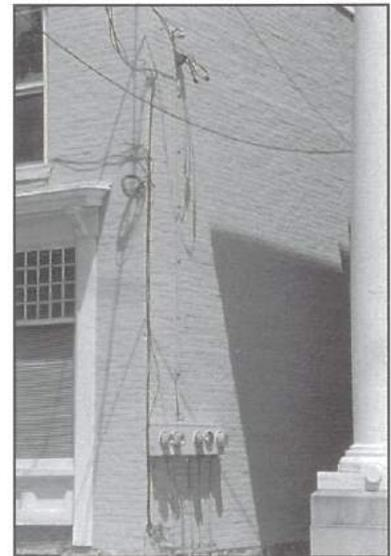
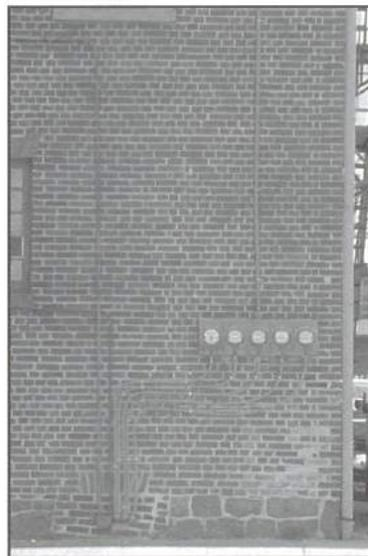

Meters and cables on brick walls in Gettysburg.

### Meter Boxes

- Utility meters, wires, piping, boxes, and related equipment should be installed in unobtrusive locations on rear or secondary walls.

**Mechanical Equipment** (including air handling units, vent stacks, chillers, condensing units, elevator equipment, rooftop access equipment, etc.)

- Grade-mounted mechanical equipment should be restricted to rear yards and inconspicuous side yards, and should be shielded with plantings or appropriate fencing.
- Keep what cannot be concealed at the rear of the house.

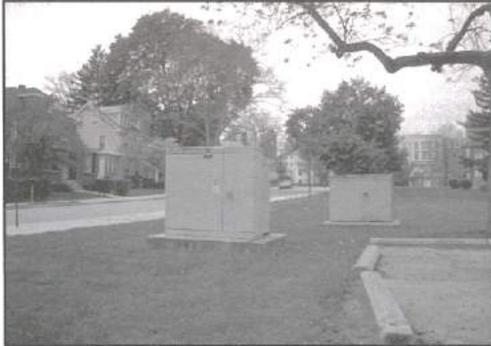

Mechanical equipment in open view near the Eisenhower House on the Gettysburg College campus.

- Equipment should not be placed on residential roofs. On other buildings, all rooftop equipment should be recessed from the edges of the roof to minimize visibility from the street.
- If additional mechanical equipment is required at the interior, avoid dropping ceilings across window openings to accommodate it.
- Do not overload the building structure with the weight of new equipment, particularly on the roof and in the attic.



A satellite dish and a dumpster in full view at the corner of Washington and W. Middle Streets.

### Satellite Dishes and Antennas

- Satellite dishes should be minimal in size.
- Satellite dishes should be attached to rear or inconspicuous side walls of buildings. Locations that are not visible from the street are preferred.
- Satellite dishes should be attached to buildings using methods that do not cause damage to building materials or to historic features.
- Antennas that are no longer functional should be removed.

## UTILITIES

### Window Air Conditioners

- Window air conditioners should be installed on rear or secondary walls, rather than primary walls.
- The use of window air conditioners should not result in the removal or replacement of window sash or in the alteration or damage of any window materials.
- Through-wall air conditioners are inappropriate for historic buildings. Avoid cutting through walls or removing other historic materials to add mechanical equipment.

### Priorities for Service Equipment in Gettysburg

- Relocate all overhead wiring underground, possibly in conduit.
- Relocate meter boxes and related equipment to unobtrusive locations.
- Increase landscaping to hide mechanical equipment throughout the borough.
- Use shutters, operable windows, porches, curtains, awnings, shade trees, and other historically appropriate non-mechanical features to reduce heating and cooling needs.

# ACCESSIBILITY

## Process for Implementing Accessibility Modifications

1. Review the historical significance of the property and identify character-defining features. Alteration of these features should be avoided when making changes or additions for accessibility.
2. Assess the existing and required levels of accessibility. Identify all barriers in the structure and on the site. Review all local codes and state and federal laws.
3. Evaluate accessibility options within a preservation context. The goal is to provide a high level of accessibility with minimal impact on the historic property.

### Note

Seek the assistance of preservation professionals, code officials, and persons with disabilities. The expertise of each will be critical in determining the full range of options for accessibility.



A ramp providing side access to the GAR Building at 53 East Middle Street.

## ACCESSIBILITY

Historically, buildings and landscapes were not designed to be readily accessible for people with disabilities. With the passage of the Americans with Disabilities Act in 1990, access to properties open to the public is now a civil right. The goal is to provide barrier free access that promotes independence for disabled persons to the highest degree practicable, while preserving significant features of the historic resource. Building accessibility for individuals with disabilities should be achieved without compromise to historic materials or to character-defining elements of historic buildings and sites. Each case is individual, but the guidelines below should be followed.

### Guidelines

- Seek to provide barrier free access that promotes independence for disabled persons to the highest degree practicable while preserving historic features.
- The design of new ramps should be compatible with the original structure and the overall site.
- Compatibility can be achieved through appropriate location. Ramps and elevators should be located on rear or secondary walls.
- Increase the compatibility of new ramps by constructing them of materials equal to or similar to the materials of adjacent stairs and walks.
- Consider providing barrier-free access through removable or portable ramps, if installing permanent ramps would damage distinctive historic features.
- Utilize landscaping elements to shield ramps and elevators.

For more information on accessibility, see *Where to Go for Help* near the end of this manual.



# NEW CONSTRUCTION, ADDITIONS & DEMOLITION



The U.S. Post Office in Gettysburg in 1914, now the Adams County Public Library.  
Photo courtesy of the Borough of Gettysburg.





1



2



3



4

## NEW CONSTRUCTION ADDITIONS & DEMOLITION

New construction is a sign of economic health and community vitality. But, it leaves an indelible mark on our communities. New buildings and additions can dramatically change the appearance of a neighborhood. For this reason, new construction and additions should be compatible with historic buildings. They should not pretend to be historic or duplicate historic buildings, lest they diminish the importance of the historic buildings. New construction and additions should achieve compatibility through appropriate massing, shape, size, materials, etc.

### Borough Regulations

In addition to the review provided by HARB for new construction and additions in the historic district, there are other regulatory considerations to be taken into account for such projects. Building codes and zoning regulations of the Borough must also be met. For more information on these requirements, contact the Code Enforcement Officer at 334-1160. In addition to the borough's requirements, the county has regulations that must also be met. Call the county at 334-6781 for more information.

The Hotel Gettysburg has undergone a number of additions. 1: The hotel in 1890. 2: The hotel in 1895. Both photos featured in *Hotel Gettysburg* by E.S. Fox. 3: The hotel in 1926, with a large rear annex and an enlarged front portico. Photo courtesy of Gettysburg Borough. 4: The hotel in 1997. The photo shows the upper three stories added in 1990. The large size of the latter addition was determined appropriate for this building because of its location. Historically, in some urban areas, larger structures were often erected on corner lots than were typically erected elsewhere.

# NEW CONSTRUCTION

## Guidelines for New Construction

- New construction should be compatible with historic buildings, while maintaining a contemporary appearance.
- New buildings should not visually overpower surrounding buildings.
- New buildings should not duplicate the design of nearby historic buildings.



A new building on Steinwehr Avenue that uses forms and details that are compatible with the other buildings on the street.



A modern building with a deep setback adjacent to an historic building with a minimal setback. This change in setback breaks the continuity of the historic streetscape on West Middle Street.

## COMPATIBILITY ISSUES

New construction in the historic district of Gettysburg should relate closely to buildings in the immediate neighborhood. In the following diagrams, buildings that are shaded represent new construction.



**Size, Scale, Proportion.** New construction should relate to the dominant proportions, size and scale of buildings in the district. New construction should not exceed the height of buildings in the district by more than ten percent. Long, low buildings are inappropriate amid taller structures.

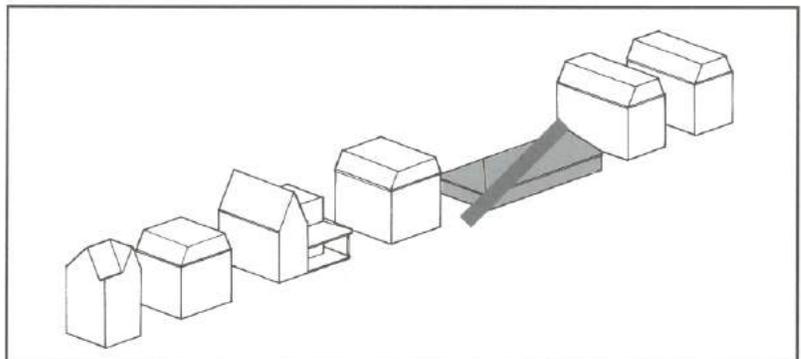

**Shape and Massing.** New construction should incorporate massing, building shapes, and roof shapes that are present in surrounding buildings.

**Materials.** Building materials should be compatible with those of the surrounding buildings. Traditional materials that are common in the district, such as wood, brick, and stone, are preferred.

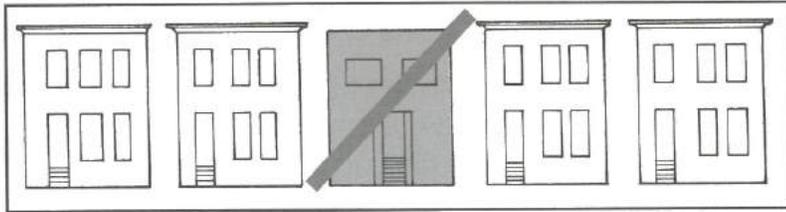

**Patterns and Rhythm.** The rhythm of facades along the street and components thereof should be maintained. Large buildings can be divided into bays to reflect neighboring rhythms.

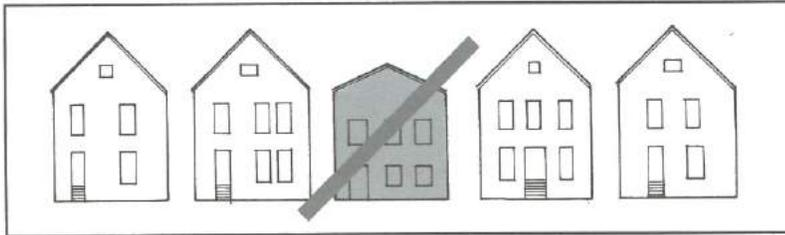

**Cornice and Floor-to-Floor Heights.** New construction should continue the floor-to-floor and cornice heights of historic buildings in the district, or should incorporate detailing that suggests those heights.

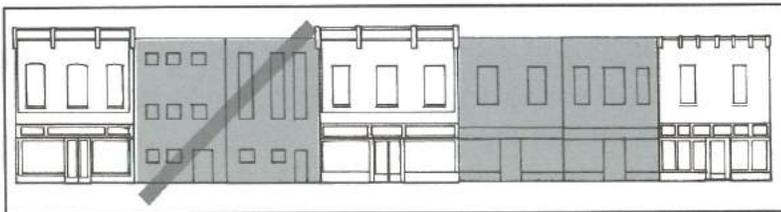

**Windows and Doors.** New construction should use window and door openings of design and size typical of those of historic buildings in the immediate neighborhood.

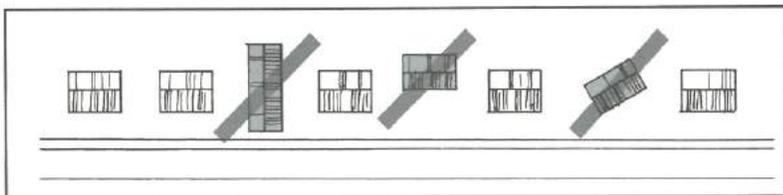

**Orientation and Location.** Principal facades of new construction should face the same direction as the rest of the buildings on the street. The prevailing setback line at the street should be preserved. For more information, see the previous chapter.

## NEW CONSTRUCTION

### Excavation and Archaeological Resources

If your building project will involve substantial excavation under or adjacent to an existing building, or to a previously undisturbed area, there may be potential to discover archaeologically important resources. Potential for this is greater on sites that were previously occupied by cemeteries. These include:

- The Old "Colored" Cemetery between 3rd and 4th Streets.
- The Old Catholic Cemetery on South Washington Street.
- The Old Presbyterian Cemetery on West High Street.

If you will be excavating in any of these areas, or if work has begun and you uncover what seems to be an important archaeological resource, call the Borough's Historic Preservation Officer at 334-1160.

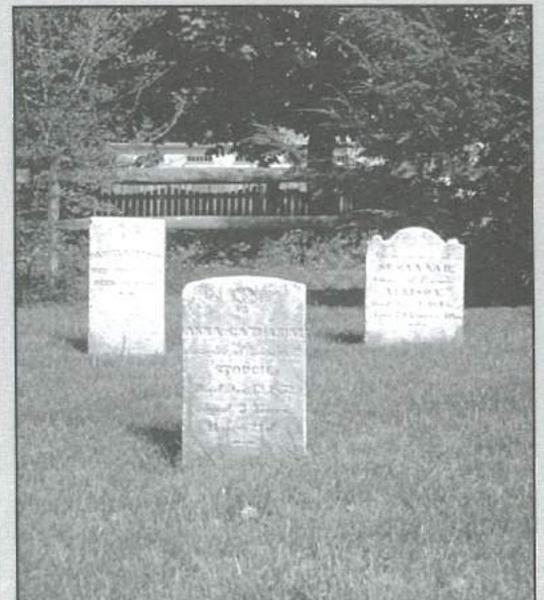

The Methodist Episcopal Cemetery.

# ADDITIONS

## Guidelines for Additions

- Construct additions to minimize the loss of historic material.
- Place additions so that they are inconspicuous to the public eye. Use rear or side walls whenever possible.
- When adding stories to a building, set them back from the front wall to differentiate them and make them less conspicuous from the street.
- Design additions so that it is clear what is historic and what is not. Contemporary designs for additions are not discouraged when compatible with the character of the building.
- Additions to non-historic buildings should not clash with or visually overwhelm nearby historic structures.
- Additions should be constructed so that their removal will not harm the historic form or integrity of the building.
- Build additions so that walls of historic buildings that face the street are not hidden, damaged, or destroyed.
- Avoid duplicating the appearance of the original building.
- Avoid using materials or details that draw attention away from the historic building.

## COMPATIBILITY ISSUES

An addition to a building in the historic district should relate closely to the existing building, while maintaining the visual prominence of the historic building. In the following diagrams, shaded buildings represent additions.

**Size, Scale, and Proportion.** The height and width of an addition should not exceed that of the historic building.

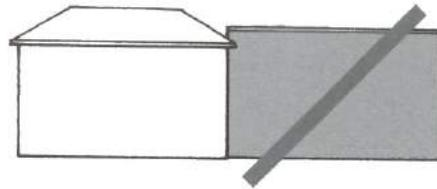
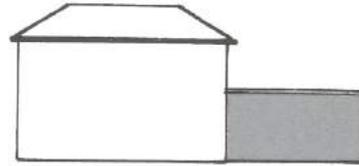

**Shape and Massing.** Additions should incorporate massing techniques used by the historic building. Using the dominant roof shape and pitch of the historic building will increase compatibility.

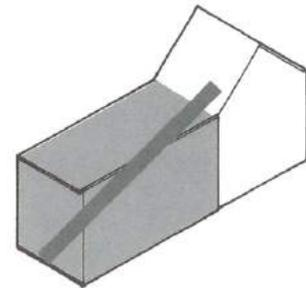
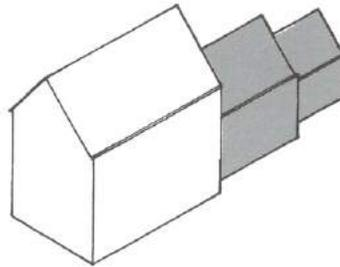

**Materials.** Building materials should be compatible with those of the historic building. Traditional materials are preferred.

**Windows and Doors.** Windows and doors in an addition to a historic building should relate in size, shape, scale, and proportion to original openings in the existing building.

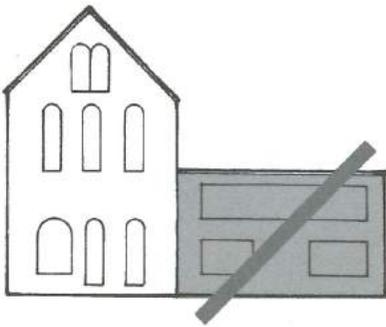
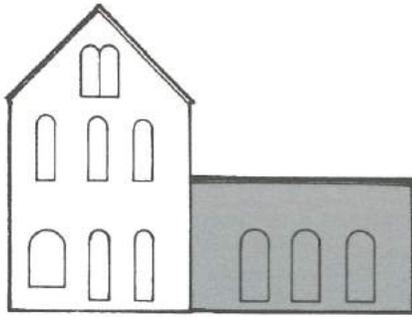

**Floor-to-Floor Heights.** Additions should conform to the floor-to-floor heights of the historic building, or should incorporate detailing that suggests consistent floor-to-floor heights.

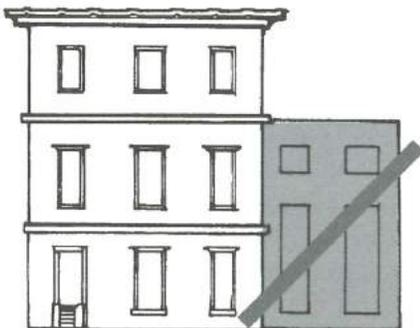
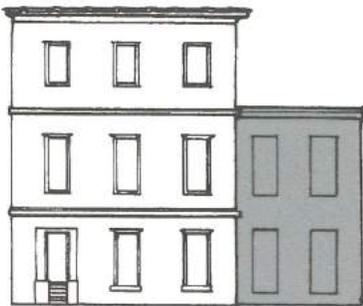

## ADDITIONS

### Location

Additions should maintain the proportions and profile of the original building. Position additions at the rear or on view-obstructed sides of buildings.

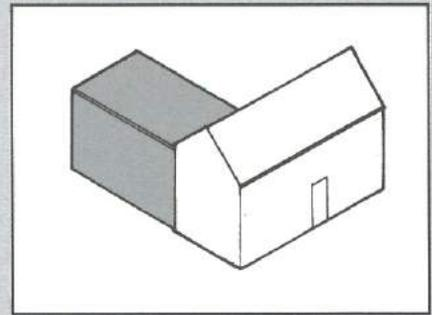

Set additions back from the front wall of the existing building.

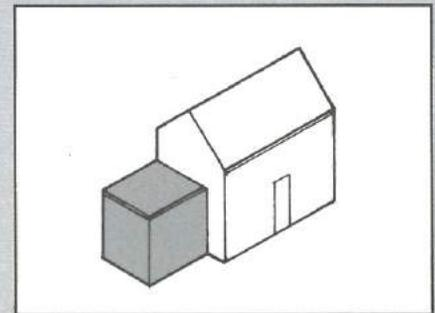

Construct additions so that important details and materials of the historic building are not hidden, damaged, or destroyed.

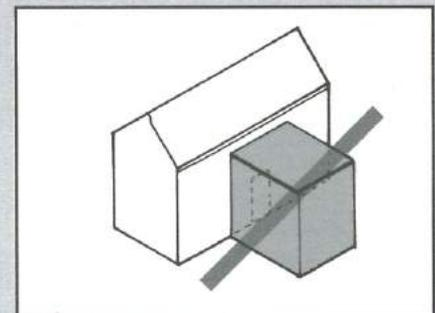

# ADDITIONS

## Additions in Gettysburg



The recessed location and use of transparent glass in this added passageway at 143 Carlisle Street help make this new structure compatible with the adjacent historic buildings.



The addition to this building at 10 East Broadway uses similar materials and a setback to increase its compatibility with the original building.



The Glatfelter Hall elevator tower addition uses appropriate massing, placement, materials, and arched window openings to make it compatible with the historic structure.

## OPTIONS FOR ADDITIONS

- 1 FIRST CHOICE:** Accommodate the new use proposed for the addition in an existing area of the historic building rather than construct an addition.
- 2 SECOND CHOICE:** Locate the addition on the rear wall of the building, following the guidelines below, if that wall is not readily visible from a public street or alley, and if no historic materials or features will be damaged or destroyed.

The placement, massing, and materials of the rear addition to the Presbyterian Church office at 208 Baltimore Street help make it compatible with the historic structure.



- 3 THIRD CHOICE:** Locate the addition on a side wall that is shielded from public view, following the guidelines on the previous page, if no historic materials or features will be negatively affected.



The placement of a one story addition in front of the main walls of this building at the corner of S. Washington and W. Middle Streets significantly altered the appearance, character and integrity of the historic structure.



# DEMOLITION

The demolition of a historic structure is irreversible and its negative impact is far-reaching. Demolition is not an appropriate treatment for historic buildings because:

- The demolition of a building can have great negative social and psychological effects on the residents of a neighborhood. The loss of familiar and meaningful landmarks is disturbing, upsets the established sense of community, and decreases livability.



This building previously stood at 135 West Middle Street. It was demolished in 1994. Photo courtesy of Gettysburg Borough.

- Demolition also has a negative effect on the environment and the economy. It adds materials to our already overcrowded landfills, and it necessitates the use of money, energy, and materials to rebuild, with the energy and materials coming from already depleted natural resources.
- A demolished historic building is a lost educational resource. It can no longer illustrate the accomplishments of historical figures, the occurrence of historical events, or the construction techniques of the past.

- The demolition of a historic building creates a great physical loss in the streetscape. The loss is particularly harsh in a historic area that derives its character from the consistent appearance of more or less equally spaced buildings on the street.

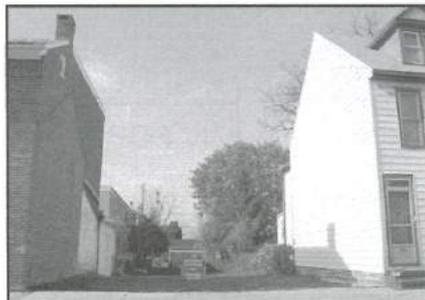

Demolition creates a dramatic physical loss in the streetscape. The building pictured in the photo at the top of the page previously stood in this empty lot.

Demolished buildings cannot be recreated. Because demolition can have such severe, long-term impact, it is considered appropriate in very few cases.

## When DEMOLITION *may* be Appropriate:

1. When the public safety and welfare requires the removal of the structure.
2. When the structural instability of the building has been amply demonstrated by the report of an engineer or architect, and after sufficient documentation.
3. When the building does not contribute to the historic district.
4. When economic hardship requirements have been met.

# DEMOLITION

## Demolition of Parts of Buildings

Demolition of any part of a building in the Gettysburg Historic District requires a permit, and, because all parts of a building contribute to the overall character of the building, demolition in part is rarely advisable. This type of demolition may be appropriate when the building element:

- Is deteriorated beyond repair,
- Is in danger of collapse,
- Cannot be stabilized,  
**and**
- Only after it has been thoroughly documented.

Removal of building elements is not acceptable if an appropriate replacement will not be constructed. If any building elements are removed, they should be recorded in photos prior to removal and should be stored for future use.

## Guidelines for Demolition of Historic Structures:

- Document the structure with photographs and/or in drawings before demolition.
- Ensure that demolition will not damage other historic buildings.
- Consider donating salvageable materials (such as windows, doors, bricks, or siding) to an architectural warehouse, so that they may be used for other projects.

# DEMOLITION

## THE DEMOLITION APPROVAL AND PERMIT PROCESS IN GETTYSBURG

A permit is required for the demolition of any building, or any part of any building, in the historic district in Gettysburg. The steps of the demolition approval and permit process are outlined below. All HARB recommendations are forwarded to Borough Council for final decisions.

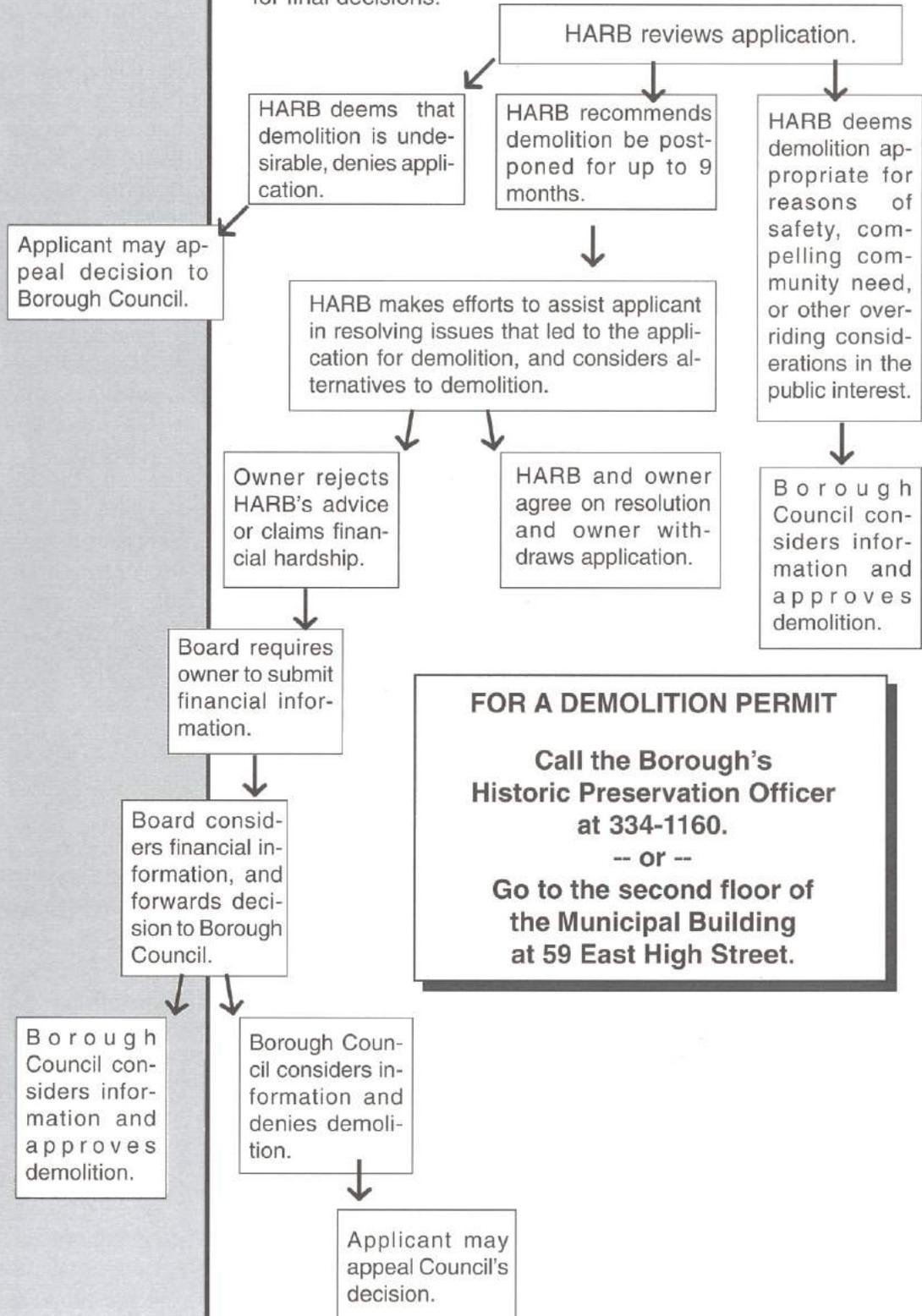

**FOR A DEMOLITION PERMIT**

**Call the Borough's  
Historic Preservation Officer  
at 334-1160.**

**-- or --**

**Go to the second floor of  
the Municipal Building  
at 59 East High Street.**

# APPENDICES



View in front of the Wills House and the Masonic Building around 1925.  
Photo courtesy of the Borough of Gettysburg.



# WHERE TO GO FOR HELP



The Adams County Prison, today the Gettysburg Municipal Building, on East High Street around 1888. Photo courtesy of the Adams County Historical Society.



## WHERE TO GO FOR HELP

Listed on the following pages are a variety of resources -- organizations and publications -- that can be consulted for additional help and information in maintaining and rehabilitating historic buildings. Sources on general maintenance and rehabilitation are listed, as are sources for each of the broad topics covered in this manual.



The Adams County Public Library at 140 Baltimore Street.

# WHERE TO GO FOR HELP

## ORGANIZATIONS

### Local

Adams County Historical Society  
Schmucker Hall  
Lutheran Theological Seminary  
111 N. West Confederate Avenue  
PO Box 4325  
Gettysburg, PA 17325  
717-334-4723

Adams County Public Library  
Historic Preservation Section  
140 Baltimore Street  
Gettysburg, PA 17325  
717-334-5716

Gettysburg Historic Architectural  
Review Board (HARB)  
Historic Preservation Officer  
59 E. High Street  
Gettysburg, PA 17325  
717-334-1160

Gettysburg National Military Park  
Cultural Resource Management/  
Maintenance  
Taneytown Road  
Gettysburg, PA 17325  
717-334-5533

Preservation Society of Gettysburg -  
Adams County  
12 Lincoln Square  
Gettysburg, PA 17325  
717-334-8188

## BOOKS AND OTHER PUBLICATIONS

### Maintenance

Becher, Norman. *Complete Book of Home Inspection*. New York: McGraw Hill, 1980.

Chambers, J. Henry, AIA. *Cyclical Maintenance for Historic Buildings*. Washington, DC: National Park Service, 1976.

Depew, Ned. *House Inspection: A Homebuyer's/Homeowner's Guide*. Spencertown, NY: Golden Hill Press, 1992.

*Old-House Journal*: "Getting Rid of Lead," July/Aug. 1992; "Keeping Radon Out of Old Houses," Mar/Apr, 1995.

Pennsylvania Department of Environmental Protection. *Pennsylvania's Home Buyer's and Seller's Guide to Radon and Pennsylvania's Consumer's Guide to Radon Reduction*.

Preservation Brief #31: *Mothballing Historic Buildings*.

Reynolds, Judith. "Appraising Historic Properties." *Preservation Information Series*. National Trust for Historic Preservation.

Seaquist, Edgard O., Jr. *Diagnosing and Repairing House Structure Problems*. New York: McGraw Hill, Inc., 1980.

United States Environmental Protection Agency. *Reducing Lead Hazards When Remodeling Your Home*. April, 1994. *Protect Your Family From Lead in Your Home*. May, 1995.

Wagner, John D. and Marylee MacDonald. "Keeping Radon Out of Old Houses." *Old-House Journal*. March/Apr., 1995. p. 58-61.

Weeks, Kay D. and Anne E. Grimmer. *The Secretary of the Interior's Standards for the Treatment of Historic Properties with Guidelines for Preserving, Rehabilitating, Restoring and Reconstructing Historic Buildings*. Washington, DC: National Park Service, 1995.

### General Rehabilitation

Bernhard, Sandy and Tom Ela. *The House Journal: A Resource to Evaluate and Document the History, Alterations, and Records of Your House and Property*. Washington, DC: The Preservation Press, 1993.

Groenendall, Denson, The Pennsylvania State University, and the Bureau for Historic Preservation, Pennsylvania Historical and Museum Commission. *Repair and Preservation Maintenance for Historic and Older Homes*. University Park and Harrisburg, PA, 1982.



Hanson, Shirley and Nancy Hubby. *Preserving and Maintaining the Older Home*. New York: McGraw-Hill Book Company, 1983.

Hotton, Peter. *So You Want to Fix Up an Old House*. Boston: Little, Brown, 1979.

Jackson, Albert and David Day. *The Complete Home Restoration Manual*. New York: Simon & Schuster, 1992.

Johnson, Allen F. *How To Care for Your Old House: An Owner's Manual*. New Haven: Connecticut Trust for Historic Preservation, 1987.

Kass, Stephen L., Judith M. LaBelle, and David A. Hansell. *Rehabilitating Older and Historic Buildings: Law, Taxation, Strategies*. Second Edition. New York: John Wiley & Sons, Inc., 1993.

Kitchen, Judith L. *Caring for Your Old House: A Guide for Owners and Residents*. Washington, DC: The Preservation Press, 1991.

McGowan, John and Roger DuBern. *The Book of Home Restoration*. New York: Gallery Books, 1985.

National Park Service. *Maintaining Historic Buildings* (A NPS Reading List). Washington, DC: National Park Service, 1990.

National Park Service. *Respectful Rehabilitation: Answers to Your Questions About Old Buildings*. Washington, DC: Preservation Press, 1982.

National Trust for Historic Preservation. "Safety, Building Codes and Historic Buildings." (*Preservation Information Series*, No. 57, 1992.)

National Trust for Historic Preservation. "Basic Preservation Procedures." (*Preservation Information Series*, No. 48, 1991.)

Poore, Patricia (ed.). *The Old-House Journal: Guide to Restoration*. New York: Dutton, 1992.

Preservation Brief #16: *The Use of Substitute Materials on Historic Building Exteriors*.

Preservation Brief #17: *Architectural Character: Identifying the Visual Aspects of Historic Buildings as an Aid to Preserving their Character*.

Preservation Brief #37: *Appropriate Methods for Reducing Lead Paint Hazards in Historic Housing*.

Preservation Brief #39: *Holding the Line: Controlling Unwanted Moisture in Historic Buildings*.

## WHERE TO GO FOR HELP

### ORGANIZATIONS

#### State and Regional

Bureau for Historic Preservation  
Pennsylvania Historical and Museum  
Commission  
PO Box 1026  
Harrisburg, PA 17108-1026  
717-783-8946

Historic Harrisburg Association  
PO Box 951  
Harrisburg, PA 17108  
717-233-4646

Historic York, Inc.  
The Architectural Warehouse  
224 N. George Street  
York, PA 17401  
717-854-7152

# WHERE TO GO FOR HELP

## ORGANIZATIONS

### National

Association for Preservation Technology  
PO Box 8178  
Fredericksburg, VA 22404  
713-373-1621

National Park Service  
Preservation Training Center  
4801 A Urbana Pike  
Frederick, MD 21704  
Phone 301-663-8206  
Fax 301-663-8032

National Trust for Historic Preservation  
Mid-Atlantic Regional Office  
1617 JFK Blvd., Suite 1520  
Philadelphia, PA 19103  
215-568-8162

Santucci, Robert M., Brooke C. Stoddard and Peter Werwath. *A Consumer's Guide to Home Improvement, Renovation and Repair*. Revised Edition. New York: John Wiley & Sons, Inc., 1995.

Simonson, Kaye Ellen. *Maintaining Historic Buildings: An Annotated Bibliography*. Washington, DC: National Park Service, 1990.

Smith, Gretchen (ed.). *Respectful Rehabilitation*. Washington, DC: The Preservation Press, 1982.

Stahl, Frederick A. *A Guide to the Maintenance, Repair, and Alteration of Historic Buildings*. New York: Van Nostrand Reinhold Company, 1984.

Stephen, George. *Remodeling Old Houses Without Destroying Their Character*. New York: Alfred A. Knopf, 1972.

### Wood

Johnson, Ed. *Old-House Woodwork Restoration*. Prentice Hall, 1983.

O'Bright, Alan. *Paint Removal from Wood Siding*. (Preservation Tech Notes, Number 2.) National Park Service, Preservation Assistance Division.

Park, Sharon C. *Exterior Woodwork*. (Preservation Tech Notes, Number 1.) National Park Service, Preservation Assistance Division.

Preservation Brief #8: *Aluminum and Vinyl Siding on Historic Buildings*.

Preservation Brief #10: *Exterior Paint Problems on Historic Woodwork*.

Preservation Brief #16: *The Use of Substitute Materials on Historic Building Exteriors*.

Preservation Brief #26: *The Preservation and Repair of Historic Log Buildings*.

Sheetz, Ron and Charles Fisher. *Exterior Woodwork*. (Preservation Tech Notes, Number 4.) National Park Service, Preservation Assistance Division.

Shivers, Natalie. *Walls and Molding: How to Care for Old and Historic Wood and Plaster*. Washington, DC: The Preservation Press, 1990.

---

## Masonry

Aldrich, Dr. Harl, Jr. "Preserving the Foundations of Older Buildings: The Importance of Groundwater Levels." *Technology & Conservation*. Summer, 1979. p. 32-37.

Bryant, Terry. "Protecting Exterior Masonry from Water Damage: Moisture Control Procedures & Products." *Technology & Conservation*. Spring, 1978. p. 38-42.

Grimmer, Anne E. *A Glossary of Historic Masonry Deterioration Problems and Preservation Treatments*. Washington, DC: National Park Service, 1984.

Grimmer, Anne E. *Keeping it Clean: Removing Exterior Dirt, Paint Stains and Graffiti from Historic Masonry Buildings*. Washington, DC: National Park Service.

Hutchins, Nigel. *Restoring Houses of Brick and Stone*. New York: Van Nostrand Reinhold, 1982.

London, Mark. *Masonry: How to Care for Old and Historic Brick and Stone*. Washington, DC: The Preservation Press, 1988.

McKee, Harley J. *Introduction to Early American Masonry: Stone, Brick, Mortar and Plaster*. Washington, DC: The Preservation Press, 1973.

Preservation Brief #1: *The Cleaning and Waterproof Coating of Masonry Buildings*.

Preservation Brief #2: *Repointing Mortar Joints in Historic Brick Buildings*.

Preservation Brief #6: *Dangers of Abrasive Cleaning to Historic Buildings*.

Preservation Brief #7: *Preservation of Historic Glazed Architectural Terra-Cotta*.

Preservation Brief #15: *Preservation of Historic Concrete: Problems and General Approaches*.

Preservation Brief #22: *The Preservation and Repair of Historic Stucco*.

Preservation Brief #38: *Removing Graffiti from Historic Masonry*.

Smith, Baird W. *Moisture Problems in Historic Masonry Walls: Diagnosing and Treatment*, 1984.

Weiss, Norman R. "Cleaning of Building Exteriors: Problems and Procedures of Dirt Removal." *Technology & Conservation*. Fall, 1976. p. 8-11.

---

# WHERE TO GO FOR HELP

---

## DICTIONARIES

Bucher, Ward (ed.) *Dictionary of Building Preservation*. New York: John Wiley & Sons, 1996.

Harris, Cyril M. (Ed.). *A Dictionary of Architecture and Construction*. McGraw Hill, Inc., 1975.

Philbin, Tom. *The Illustrated Dictionary of Building Terms*. New York: McGraw-Hill, 1997.

Phillips, Steven J. *Old House Dictionary: An Illustrated Guide to American Domestic Architecture 1600-1940*. Washington, DC: The Preservation Press, 1992.

# WHERE TO GO FOR HELP

## ARCHITECTURAL STYLE GUIDES

Blumenson, J.G. *Identifying American Architecture: A Pictorial Guide to Styles and Terms, 1600-1945*. Rev. ed. New York: W.W. Norton, 1981.

McAlester, Virginia and Lee. *A Field Guide to American Houses*. New York: Alfred A. Knopf, 1984.

Poppeliers, John, et al. *What Style is it? A Guide to American Architecture*. Rev. ed. Washington, DC: Preservation Press, 1983.

Rifkin, Carole. *A Field Guide to American Architecture*. New York: New American Library, 1980.

## Windows and Doors

*Old-House Journal*. "Back on Track: Getting the Kinks out of Pocket Doors." Nov./Dec., 1994. "Brilliant Cut Glass." Nov./Dec., 1992. "Curing Ailing Sills." Mar./Apr., 1994. "A Homeowner's Guide to Stained Glass." Jan./Feb., 1994. "Sash Window Workshop." Sep./Oct., 1991. "Shopping for Special Door Hinges." Nov./Dec., 1992. "A Window on Sash Repair." May/June, 1995.

Historic Preservation Education Foundation. *The Window Handbook: Successful Strategies for Rehabilitating Windows in Historic Buildings*. Historic Preservation Education Foundation, 1990.

National Park Service. *Window Rehabilitation Guide for Historic Buildings*. National Park Service and the Historic Preservation Education Foundation, 1997.

New York Landmarks Conservancy. *Repairing Old and Historic Windows: A Manual for Architects and Homeowners*. Washington, DC: The Preservation Press, 1992.

Preservation Brief #3: *Conserving Energy in Historic Buildings*.

Preservation Brief #9: *The Repair of Historic Wooden Windows*.

Preservation Brief #13: *The Repair and Thermal Upgrading of Historic Steel Windows*.

Preservation Brief #33: *Preservation and Repair of Historic Stained and Leaded Glass*.

Prueher, Brooks (compiler). *Window Directory for Historic Buildings*. Washington, DC: National Park Service, 1996.

## Porches

Kahn, Renee and Ellen Meagher. *Preserving Porches*. New York: Henry Holt and Company, 1990.

*Old-House Journal*: "Hitting on Porch Decks." July/Aug., 1993; "Sleeping Porches" July/Aug., 1995.

## Roofs

*Old-House Journal*: "The Chimney Detective: Tracking Moisture at the Stack." Nov./Dec., 1995; "Flashing Points: A Primer on Protecting Roof Junctures." Nov./Dec., 1995; "Frost in the Rafters, Ice on the Eaves." Nov./Dec., 1993; "Half-Round Metal Gutters." July/Aug., 1992; "Laying a Standing Seam Metal Roof." Sep./Oct., 1994; "Making Sense of Metal Roofs." July/Aug., 1992; "Picturesque Slate: Understanding the Architecture of Rustic

Roofs." Sep./Oct., 1995; "Rock 'n Roll Roofing." July/Aug., 1995; "Roofing Over the Roof." Sep./Oct., 1988; "Slate & Shingle Lookalikes." Sep./Oct., 1994; "Wood Shingle Report." Sep./Oct., 1994.

Preservation Brief #4: *Roofing for Historic Buildings*.

Preservation Brief #19: *The Repair and Replacement of Historic Wooden Shingle Roofs*.

Preservation Brief #29: *The Repair, Replacement and Maintenance of Historic Slate Roofs*.

Preservation Brief #30: *The Preservation and Repair of Historic Clay Tile Roofs*.

### Exterior Color

Moss, Roger A. *Century of Color: Exterior Decoration for American Buildings, 1820-1920*. American Life Foundation, 1980.

Moss, Roger W. And Gail Caskey Winkler. *Victorian Exterior Decoration*. New York: Henry Holt and Co., 1987.

*Old-House Journal*. "The Case Against Removing Paint from Brick Masonry," Feb., 1975; "Checklist for Painting," May, 1986; "Exterior Painting," April, 1981; "Prior to Paint," July/Aug., 1994; "Restoring a Frame House Exterior," Sep., 1974; "Stripping Paint from Exterior Wood," Dec., 1985; "Stripping Exterior Masonry," Jan./Feb., 1985.

"Painting the House." *Consumer Reports*. September, 1995. p. 610-615.

Preservation Brief #10: *Exterior Paint Problems on Historic Woodwork*.

Preservation Brief #28: *Painting Historic Interiors*.

Schwin, Lawrence III. *Old House Colors: An Expert's Guide to Painting Your Old (Or Not So Old) House*. New York: Sterling Publishing Co., 1990.

Weeks, Kay D. and David W. Look. "Paint on Exterior Historic Woodwork: Identification & Treatment of Surface Condition Problems." *Technology and Conservation*. Summer, 1982. p. 34-46.

### Commercial Buildings and Signs

Marinelli, Janet. "Architectural Glass and the Evolution of the Storefront." *Old-House Journal*. July/Aug., 1988. p. 34-43

Marinelli, Janet and Gordon Bock. "Streetscapes." *Old-House Journal*. July/Aug., 1988. p. 46-55.

## WHERE TO GO FOR HELP

### PERIODICALS

*APT Bulletin*. Association for Preservation Technology, PO Box 8178, Fredericksburg, VA 22404, 713-373-1621/1622.

*Historic Preservation and Preservation News*. Published by the Preservation Press. National Trust for Historic Preservation, 1785 Massachusetts Avenue, NW, Washington, DC 20036, 202-673-4070.

*Old-House Journal*. 435 Ninth Street, Brooklyn, NY 11215, 718-788-1700.

*Preservation Forum*. National Trust for Historic Preservation, 1785 Massachusetts Avenue, NW, Washington, DC 20036, 202-673-4037.

*Traditional Building: The Professional Source for Historical Products*. 69A Seventh Avenue, Brooklyn, NY 11217.

# WHERE TO GO FOR HELP

## PRESERVATION BRIEFS

Preservation Briefs are produced by the National Park Service and may be ordered by contacting: The Superintendent of Documents, Government Printing Office, Washington, DC, 20402-9325, 202-512-1800.

- #1: The Cleaning and Waterproof Coating of Masonry Buildings.
- #2: Repointing Mortar Joints in Historic Brick Buildings.
- #3: Conserving Energy in Historic Buildings.
- #4: Roofing for Historic Buildings.
- #5: The Preservation of Historic Adobe Buildings.
- #6: Dangers of Abrasive Cleaning to Historic Buildings.
- #7: The Preservation of Historic Glazed Architectural Terra Cotta.
- #8: Aluminum or Vinyl Siding on Historic Buildings: The Appropriateness of Substitute Materials for Resurfacing Historic Wood Frame Buildings.
- #9: The Repair of Historic Wooden Windows.
- #10: Exterior Paint Problems on Historic Woodwork.
- #11: Rehabilitating Historic Storefronts.
- #12: The Preservation of Pigmented Structural Glass (Vitrolite and Carrara Glass).
- #13: The Repair and Thermal Upgrading of Historic Steel Windows.
- #14: New Exterior Additions to Historic Buildings.
- #15: Preservation of Historic Concrete: Problems and General Approaches.
- #16: The Use of Substitute Materials on Historic Building Exteriors.
- #17: Architectural Character: Identifying the Visual Aspects of Historic Buildings as an Aid to Preserving their Character.

continued on the next page

Preservation Brief #11: *Rehabilitating Historic Storefronts*; Preservation Brief #12: *Preservation of Historic Pigmented Structural Glass*; Preservation Brief #25: *Preservation of Historic Signs*; Preservation Brief #27: *The Maintenance and Repair of Architectural Cast Iron*.

### Outbuildings and Sitework

Gayle, Margot, et al. *Metals in America's Historic Buildings: Uses and Preservation Treatments*. Washington, DC: National Park Service, 1980.

Geist, Kevin. *How to Build Wooden Gates and Picket Fences: 100 Classic Designs*. Mechanicsburg, PA: Stackpole Books, 1994.

Magaziner, Henry J. "The Art of Ironwork." *Old-House Journal*. May/June, 1997. p. 33-39.

Preservation Brief #20: *Preservation of Historic Barns*; Preservation Brief #36: *Preserving Cultural Landscapes: Planning Treatments and Management of Historic Landscapes*.

Prowell, Charles. "One Barn's Return: Three Fixes for Bulging Outbuildings." *Old-House Journal*. July/Aug., 1995. p. 44-47.

Southworth, Susan and Michael. *Ornamental Ironwork: An Illustrated Guide to Its Design History and Use in American Architecture*. Boston: David R. Godine, 1978.

### Utilities and Accessibility

Jester, Thomas C. *Preserving the Past and Making it Accessible for People with Disabilities*. Washington, DC: National Park Service, 1992.

National Trust for Historic Preservation. "The Impact of the Americans With Disabilities Act on Historic Structures." (*Preservation Information Series*, No. 55, 1991.)

Preservation Brief #24. *Heating, Ventilating, and Cooling Historic Buildings: Problems and Recommended Approaches*; Preservation Brief #32. *Making Historic Properties Accessible*.

*Standards for Accessible Design: ADA Accessibility Guidelines (ADAAG)*. Washington, DC: U.S. Department of Justice, 1991.

### Additions, New Construction, Demolition

*Old-House Journal*. "Making Sense of Sensitive Additions: Ways to Get a Handle on Enlarging Old Houses." May/June, 1995; "The Old Way of Seeing Additions." May/June, 1995.

Preservation Brief #14: *New Exterior Additions to Historic Buildings*.

## Gettysburg History, Architecture, and Archaeological Resources

Baker, Rev. Joseph B. *History of St. James Evangelical Lutheran Church of Gettysburg, Pennsylvania., 1775-1921.* Gettysburg: By the author, 1921.

Bennett, Gerald R. *"Days of Uncertainty and Dread": The Ordeal Endured by the Citizens at Gettysburg.* Littlestown, PA: By the Author, 1994.

Bloom, Robert L. *A History of Adams County, Pennsylvania, 1700-1990.* Gettysburg: The Adams County Historical Society, 1992.

Bloom, Robert L. "We Never Expected a Battle': The Civilians at Gettysburg, 1863." *Pennsylvania History* 55 (October 1988), 161-200. Reprint by the Adams County Historical Society.

Borough of Gettysburg. "Historic Resource Survey Forms, 1988-1991." Vertical Files, Gettysburg Borough. (Copies also available at the Adams County Historical Society.)

Christ, Elwood W. and Walter L. Powell, "Gettysburg Historic Building Survey Committee Data Analysis/Final Report/Historic Contexts." Gettysburg Historic Architectural Review Board, December 1988. Vertical Files, Gettysburg Borough.

Coco, Gregory A. *A Vast Sea of Misery: A History and Guide to the Union Confederate Field Hospitals at Gettysburg, July 1-November 20, 1863.* Gettysburg: Thomas Publications, 1988.

Cole, James M. *For God and Country: A History of St. Francis Xavier Church, 1831-1981.* Gettysburg: St. Francis Xavier Parish, 1861.

Fischler, Benjamin R. and Elwood W. Christ. *Preliminary Report on Phase II Archaeological and Historical Investigations of the Samuel Gettys Farm/Tavern Site.* Gettysburg: Borough of Gettysburg, 1990.

Fox, Elise Scharf. *Hotel Gettysburg: A Landmark in Our Nation's History.* Gettysburg: Downtown Gettysburg, Inc., 1988.

Frassanito, William A. *Early Photography at Gettysburg.* Gettysburg: Thomas Publications, 1995.

Frassanito, William A. *Gettysburg: A Journey in Time.* New York: Charles Scribner's Sons, 1975.

Frassanito, William A. *The Gettysburg Bicentennial Album.* Gettysburg: Gettysburg Bicentennial Committee, 1987.

Glatfelter, Charles H. *A Salutary Influence: Gettysburg College, 1832-1985.* 2 vols. Gettysburg: Gettysburg College, 1987.

## WHERE TO GO FOR HELP

### PRESERVATION BRIEFS (cont.)

- #18: Rehabilitating Interiors in Historic Buildings.
- #19: Repair and Replacement of Historic Wooden Shingle Roofs.
- #20: The Preservation of Historic Barns.
- #21: Repairing Historic Flat Plaster: Walls and Ceilings.
- #22: The Preservation and Repair of Historic Stucco.
- #23: Preserving Historic Ornamental Plaster.
- #24: Heating, Ventilating and Cooling Historic Buildings: Problems and Recommended Approaches.
- #25: The Preservation of Historic Signs.
- #26: The Preservation and Repair of Historic Log Buildings.
- #27: The Maintenance and Repair of Architectural Cast Iron.
- #28: Painting Historic Interiors.
- #29: The Repair, Replacement and Maintenance of Historic Slate Roofs.
- #30: The Preservation and Repair of Historic Clay Tile Roofs.
- #31: Mothballing Historic Buildings.
- #32: Making Historic Properties Accessible.
- #33: Preservation and Repair of Historic Stained and Leaded Glass.
- #34: Applied Decoration for Historic Interiors: Preserving Composition Ornament.
- #35: Understanding Old Buildings: The Process of Architectural Investigation.
- #36: Preserving Cultural Landscapes: Planning Treatments and Management of Historic Landscapes.
- #37: Appropriate Methods for Reducing Lead-paint Hazards in Historic Housing.
- #38: Removing Graffiti from Historic Masonry.
- #39: Holding the Line: Controlling Unwanted Moisture in Historic Buildings.
- #40: Preserving Historic Ceramic Tile Floors.

# WHERE TO GO FOR HELP

## DESIGN GUIDES OF OTHER HISTORIC COMMUNITIES

The design guides and manuals from the following historic communities were valuable in the preparation of this document.

Aiken, South Carolina  
Allentown, Pennsylvania  
Annapolis, Maryland  
Beaufort, South Carolina  
Bellefonte, Pennsylvania  
Bethlehem, Pennsylvania  
Brookline, Massachusetts  
Cambridge, Massachusetts  
Cheraw, South Carolina  
Doylestown, Pennsylvania  
Galeton, Pennsylvania  
Harrisburg, Pennsylvania  
Hingham, Massachusetts  
Hollidaysburg, Pennsylvania  
Holyoke, Massachusetts  
Lowell, Massachusetts  
Lower Merion Township, Pennsylvania  
New Bedford, Massachusetts  
Oakland, California  
Penn Yan, New York  
Pottstown, Pennsylvania  
Providence, Rhode Island  
Rochester, New York  
Rock Hill, South Carolina

Glatfelter, Charles H. *Yonder Beautiful and Stately College Edifice: A History of Pennsylvania Hall (Old Dorm), Gettysburg College, Gettysburg, Pennsylvania.* Gettysburg: Gettysburg College, 1970.

Gobbel, A. Roger. *Living in the Light: A Short History in Word and Picture of St. James Evangelical Lutheran Church, Gettysburg, Pennsylvania.* Gettysburg: St. James Lutheran Church, 1989.

Goodwin, R. Christopher and Associates, Inc. *Intensive Archeological and Architectural Investigations of Portions of Ice House Square, Gettysburg, Adams County, Pennsylvania.* 3 volumes. Frederick, Maryland: R. Christopher Goodwin and Associates, 1997.

Hefelbower, Samuel G. *A History of Gettysburg College, 1832-1932.* Gettysburg: Gettysburg College, 1932.

McCarthy, John P. and Jeanne A. Ward. *An Archaeological Evaluation of the Agricultural Hall Site 36AD220, Gettysburg, Pennsylvania.* St. Paul, Minnesota: Jeanne A. Ward, Inc., 1996.

Murray, Dorothy Speicher. *A Library for Adams County.* Gettysburg: Friends of the Library, 1988.

Powell, Walter L. *The Alexander Dobbin House: A Short History.* Gettysburg: By the Author, 1986.

Powell, Walter L. *To Gettysburg by Train.* Gettysburg: Thomas Publications, 1989.

Small, Cindy L. *The Jennie Wade Story.* Gettysburg: Thomas Publications, 1991.

Smith, Timothy H. *The Story of Lee's Headquarters, Gettysburg, Pennsylvania.* Gettysburg: Thomas Publications, 1995.

Smith, Timothy H. "A Tour of Gettysburg's Visual Battle Damage" in *Adams County History* (Volume 2, 1996), pp. 4-40.

Wentz, Abdel Ross. *Gettysburg Lutheran Theological Seminary.* Volume I, History, 1826-1965. Harrisburg: The Evangelical Press, 1965.





The National Soldiers' Orphans' Homestead, July 1874,  
located across from the Gettysburg Tour Center on Baltimore Street.  
Photo courtesy of Gettysburg National Military Park.

# GUIDELINES for ARTIFICIAL SIDING



## GUIDELINES for ARTIFICIAL SIDING

When deteriorated, damaged, or lost features of a historic building need repair or replacement, it is almost always best to use historic materials. The inappropriate choice or improper installation of substitute materials can cause a radical change in a building's appearance and can cause extensive physical damage over time. Consequently, the use of substitute materials should be limited, since their use may jeopardize the integrity of the historic resource. Every means of repairing deteriorating historic materials should be examined **before** turning to substitute materials.

In some **limited** circumstances substitute materials that imitate historic materials may be used if the appearance and properties of the historic materials can be matched closely and if no damage to the remaining historic fabric will result. However, substitute materials, including artificial sidings, should be used only after **all** other options for repair and replacement **in kind** have been ruled out.

The information on the following page outlines the special circumstances under which artificial siding may be considered, and the guidelines for the installation of artificial siding under those circumstances.

This appendix is based on information found in *Preservation Brief #16: The Use of Substitute Materials on Historic Building Exteriors*, which may be consulted for additional information. (See *Where to Go for Help* for information on obtaining *Preservation Briefs*.)



When a building is in need of maintenance, such as the house on the right, some owners consider installing artificial siding. The result, seen in the house on the left, is a loss of historic character and features. Historic details have been covered (cornice), features have been removed (window trim), and the scale has been changed (different siding dimensions). (Photo courtesy of the National Park Service, from *Preservation Brief #16*.)

# GUIDELINES for ARTIFICIAL SIDING

## General Guidelines for Artificial Siding

Remember: artificial siding is supposed to be imitating wood, and it should act accordingly.

- Repair all underlying problems before applying new siding.
- Carefully compare your cost figures. Quality materials and installation may cost more than repair.
- Use the best materials and contractors available. Proper installation of quality materials is the best way to avoid additional problems.
- Only use a contractor who is willing to retain your historic trim.
- Maintain the same spacing between horizontal lines as in the original siding.
- Place the new siding in the same direction as the historic siding. Vertical siding is rarely appropriate.

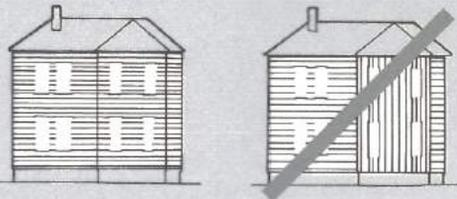

- Follow Gettysburg's Guidelines for Installing Artificial Siding, listed at the right.

## When to Consider Using Artificial Siding on a Historic Building

Because the use of substitute materials can damage or destroy the character of a historic structure, all preservation options should be explored thoroughly before substitute materials are used. In general, 4 circumstances warrant the consideration of substitute materials and 3 basic criteria must be met before substitute materials are considered. These circumstances and criteria should be closely examined for each potential siding project.

### CIRCUMSTANCES THAT WARRANT THE CONSIDERATION OF SUBSTITUTE MATERIALS

1. The unavailability of historic materials.
2. The unavailability of skilled craftsmen.
3. Inherent flaws in the original materials.
4. Code-required changes.

### CRITERIA FOR CONSIDERING SUBSTITUTE MATERIALS

1. Substitute materials must be compatible with the historic materials in appearance.
2. The physical properties of substitute materials must be similar to those of the historic materials, or the substitute materials must be installed in a manner that tolerates differences in physical properties.
3. Substitute materials must meet basic performance expectations over time. This begins with the selection of qualified, experienced fabricators and installers who are willing to preserve historic features.

### GETTYSBURG'S GUIDELINES FOR INSTALLING ARTIFICIAL SIDING

If, after thorough consideration of all options, it is determined that artificial siding is required, these guidelines must be followed:

1. The artificial siding should match the historic siding in size, profile, proportion, and general appearance.
2. "Wood" graining is never evident on properly treated wood siding, so it should not be visible on new artificial siding.
3. Place the new siding so that historic wood trim (corner boards, cornices, window and door trim, crowns and lintels) and decorative elements (brackets, architraves) remain fully visible. If the elements must be replaced, replace them with elements that match the original in material, size, profile, proportion, and general appearance.
4. Artificial siding should be installed so that it can be removed in the future with minimal damage to the historic materials of the building.
5. Allow the original siding to remain beneath the artificial siding. Provisions must be made to assure adequate ventilation for the preservation of the historic siding and underlying structure. This will maintain the future possibility of returning the building to its historic appearance.
6. The color of the artificial siding must be appropriate to the age and style of your building. (See the section on Exterior Color in this manual.)

# PAINT PROBLEMS



Looking east on Chambersburg Street from Buford Avenue around 1885.  
Photo courtesy of the Adams County Historical Society.



## PAINT PROBLEMS

The table on the following three pages provides extensive information on a variety of common paint problems. Possible causes of the problems and suggestions on how to solve them are given. If the paint on your building is deteriorated and you are unable to determine the cause of the problem, call the Historic Preservation Officer at 334-1160 for assistance.



Painting on Carlisle Street.

# PAINT PROBLEMS

## TYPICAL PAINT PROBLEMS AND POSSIBLE CAUSES

*Note: A single building may have a variety of problems; consequently, different problems will require different treatments.*

### CLASS 1: MINOR CONDITIONS THAT GENERALLY DO NOT REQUIRE PAINT REMOVAL

Symptom	Possible Cause	What to Do
Dirt	Environmental grime and organic matter accumulates over time, and is not washed away by rain and sunlight.	Be careful not to use too much water. Excess water increases the drying time required and can lead to deterioration.
Mildew	Mildew is caused by fungi that live on nutrients in the paint or on dirt adhering to the wall. It thrives in areas where excess moisture is present. If you are uncertain whether you have mildew or dirt, use this test: a drop of bleach will turn mildew white and will have little effect on dirt.	Eliminate source of moisture: Prune and trim vegetation, check drainage at base of building and at sills. Remove mildew with a mixture of one gallon warm water, one cup non-ammonia detergent, one quart household bleach. Apply. After five minutes, rinse with clean water, allow wood to dry before repainting. Repaint with "mildew-resistant" products.
Excessive Chalking	Chalking is a powdering of the paint surface that allows the paint to be rubbed off like powder. It is caused by the natural aging of the paint. As the paint ages the resin in the paint film gradually deteriorates. It can also be caused by inadequate priming or poor quality paint. Moderate chalking is not a problem because it assists in removing dirt from the surface.	The chalk should be cleaned off the surface with a solution of one-half cup household detergent and one gallon water with a medium soft bristle brush. The surface should then be rinsed with clear water, allowed to dry, and repainted before chalking reoccurs.

### CLASS 2: CONDITIONS THAT INCLUDE FAILURE OF THE TOP LAYER(S) OF PAINT & MAY REQUIRE LIMITED PAINT REMOVAL

Crazing	These fine, jagged interconnected breaks or cracks in the top layer of paint result when paint that is several layers thick becomes excessively hard and brittle with age and can't expand & contract in response to changing weather conditions. Once crazing has occurred, water enters the surface and creates more problems, like deep cracking and alligatoring.	Sand the surface by hand or with a mechanical sander. Then repaint.
---------	---	---



Peeling paint in Gettysburg.



Painting at Baltimore and West Middle Streets.



# TYPICAL PAINT PROBLEMS AND POSSIBLE CAUSES

CLASS 2 (continued)

Symptom	Possible Cause	What to Do
Intercoat Peeling	Intercoat peeling may be caused by improper surface preparation, including failure to remove salt from the surface, or by incompatibility of paint types.	In cases of improper surface preparation where impurities have caused the peeling, scrape the area, then wash it thoroughly and wipe it dry. Then sand and repaint. In cases where incompatible paints were used, scrape and sand the top coat, apply an appropriate primer and repaint with an appropriate paint.
Solvent Blistering	Solvent blistering is caused by the action of ambient heat on components of the paint. If solvent-rich paint is applied in direct sunlight, the top surface can dry too quickly, then solvents become trapped and eventually vaporize, forcing through the paint film and leaving surface blisters behind. Verify solvent blistering by cutting open a blister and finding a painted surface beneath.	Scrape the affected area, sand to the next sound layer, repaint. Do not paint in direct sunlight.
Moisture Blistering and Wrinkling 1	Moisture blistering and wrinkling occurs when the top layer of paint dries before the undercoat, then moves as the undercoat dries. This condition can be caused by applying paint too thickly, or by applying paint at a temperature not recommended by the manufacturer, or by insufficient brushing out.	Remove the wrinkled layer by scraping and sanding to an even surface, then repaint following the instructions of the manufacturer. Don't apply paint too thickly. Allow plenty of drying time between coats. Adequately brush out each coat. Don't paint in temperatures higher than those recommended by the manufacturer.
Moisture Blistering and Wrinkling 2	Moisture blistering may also be caused by outside moisture that has infiltrated under the paint layer. Rising damp (moisture penetrating up the wall from the basement) or excessive interior humidity may move through the siding and damage the paint coating.	Seek professional assistance to repair and seal basement walls, or to ventilate the space between the interior and exterior walls.

This table continues on the next page.

## PAINT PROBLEMS



Peeling paint in Gettysburg.



Painting at the corner of Baltimore and West Middle Streets.

# PAINT PROBLEMS

## TYPICAL PAINT PROBLEMS AND POSSIBLE CAUSES

*When the majority of paint will be removed from a building, it is suggested that a small area of the paint be left intact and not painted over. Identify the area in some way. This will enable future investigators to have a record of the building's paint history.*

### CLASS 3: CONDITIONS THAT INCLUDE SUBSTANTIAL FAILURE OR MULTIPLE-LAYER FAILURE AND GENERALLY REQUIRE TOTAL PAINT REMOVAL

Symptom	Possible Cause	What to Do
Peeling	Peeling to bare wood is typically caused by excess moisture collecting behind the paint film. Peeling often begins as blisters and/or cracks, and occurs as the wood swells due to the moisture. Peeling combined with brown stains near the roof may indicate ice damming. Peeling around porches might mean that gutters are not working properly.	Locate and repair the source or sources of moisture. Repair leaky gutters, downspouts, and flashing, defective roof shingles, cracks and holes in siding and trim, deteriorated caulking; trim or relocate vegetation growing too close to painted wood; ventilate high-humidity areas (kitchens, bathrooms, and laundry rooms) by adding vents and exhaust fans. After repairs, allow the wood to dry completely, then scrape, sand, prime, and repaint.
Cracking & Alligating	Cracking and alligating are advanced stages of crazing, caused by poor adhesion of the paint to the underlying surface. Once intercoat paint failure has occurred, moisture penetrates the surface cracks, the wood swells, and the cracks become deeper. Eventually the cracks extend to an overall pattern of horizontal and vertical breaks, resembling reptile skin.	If the condition has not progressed to bare wood, scrape and sand to the next sound layer. If the condition has progressed to bare wood and the paint has begun to flake, the entire paint surface must be removed. Scrape, sand, prime, and repaint.
Cracking & Alligating	Excessive layers of paint may also lead to cracking and alligating. Excessively thick paint is too brittle to recover from the shrinkage or pull of an additional coat as it dries and is less able to tolerate thermal stresses. Thick paint will fail at the layer next to the wood.	All around failure, leaving wood bare, may mean that your entire house needs better ventilation.



Peeling paint in Gettysburg.



Painting at 131 Carlisle Street.

# GLOSSARY



The Gettysburg Academy building, at the corner of West High and Washington Streets in 1882. Photo courtesy of Gettysburg National Military Park.



# GLOSSARY

Listed in this section are definitions of the technical terms used throughout this manual. For more complete listings of technical terms, see the dictionaries listed in the Appendix called *Where to Go For Help*.

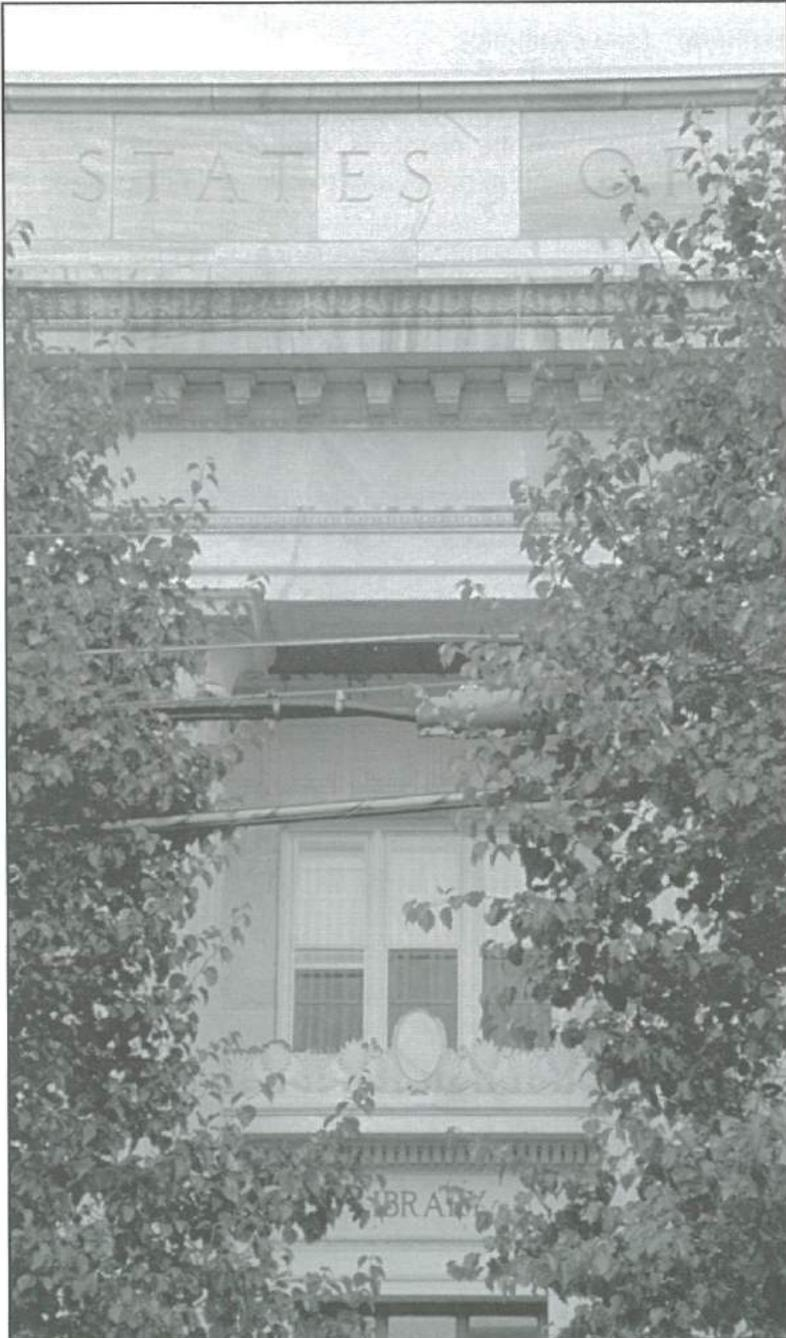

Detail of the Adams County Public Library at 140 Baltimore Street.

# GLOSSARY

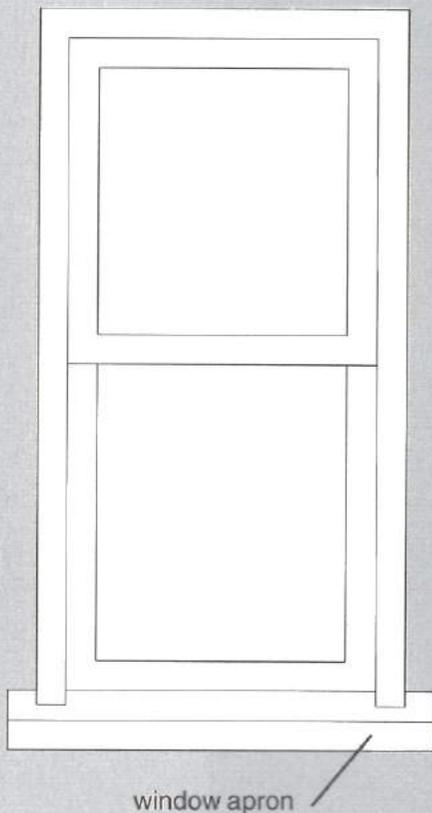

- air infiltration** - the flow of air into a building from the outside through cracks or holes in the exterior surfaces of the building
- alligating** - the splitting of a film of paint in a pattern resembling an alligator's skin
- alteration** - any physical change to an existing structure
- apron** - the facing panel, sometimes ornamented, below the floor of a porch, or the panel below a window sill
- architrave** - the lowest group of moldings on an entablature
- artificial** - (see synthetic)
- awning** - a roof-like covering placed over a door or window to provide shelter from the elements, historically constructed of fabric, but also made of metal and plastic in modern times
- baluster** - a small, column-like element that supports a hand rail in a balustrade, may be simple or decorative
- balustrade** - a railing on a stair, porch, or other structure, composed of upper and lower rails and a series of balusters in between
- bargeboard** - a decorative board, typically one of a pair, placed at the edge of the eaves of a gable
- bay window** - a window unit that projects outward from the wall of a building and usually has a foundation of its own
- blocking in** - the process by which one of a variety of materials is added to a window or door opening to decrease the size of the opening, or to close the opening completely
- board and batten** - a type of wooden siding composed of vertical boards that are covered at the joints with narrow boards (called battens)
- bond/bonding pattern** - the pattern in which bricks or stones are arranged in the formation of a wall
- bracket** - a general term for an architectural feature, typically treated with scrolls or ornament, projecting from a wall and intended to support a weight, such as a cornice, etc.
- bulkhead** - the panel at the base of the display windows of a storefront
- casement** - a window sash that opens by swinging in or out to one side

**caulking** - a flexible material used to seal cracks and fill joints between materials, intended to prevent leakage and/or to provide waterproofing

**Certificate of Appropriateness** - the approval statement, recommended by the Historic Architectural Review Board and approved by Borough Council, that certifies the appropriateness of a particular request for the construction, alteration, reconstruction, repair, restoration, demolition, or razing of all or part of any building within an historic district, following a determination of suitability according to applicable criteria, and that authorizes the issuance of a building permit for such request

**chalking** - a powdering of the surface of paint caused by natural aging

**character** - the combination of distinguishing attributes belonging to a building, structure, or other resource

**character-defining feature** - any distinguishable architectural element or characteristic that distinguishes a building or other resource, assists in classifying it as a particular type, style, form, etc., and distinguishes it from other resources

**chimney** - a structure that encloses one or more flues for the conveyance of smoke to the outside of a building, especially the part of the structure that rises above the roof, but also the part that may rise along the side wall of a building

**clapboard** - an exterior horizontal wood siding applied so that the thicker edge of each board overlaps the thinner edge of the board below

**classical** - relating to the style of ancient Greek or Roman art or architecture, or of derivatives of those styles

**column** - a vertical architectural element intended to support a load and usually composed of a base, shaft, and capital, often reflecting classical detailing

**compatible** - describing an alteration that maintains or restores the historic and significant features and appearance of a building, and does not detract from surrounding resources, thereby maintaining a sense of visual harmony in the building and between the building and neighboring buildings

**compatible substitute** - a new material used to replace an old material, the new material being similar to the old in all aspects of appearance and agreeable to the existing materials in physical and chemical properties

## GLOSSARY

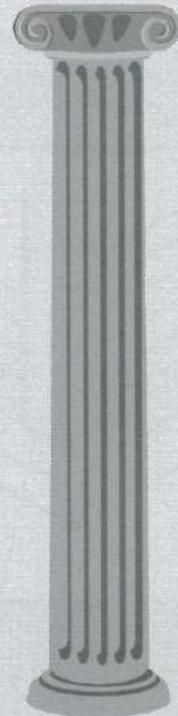

column

# GLOSSARY

---

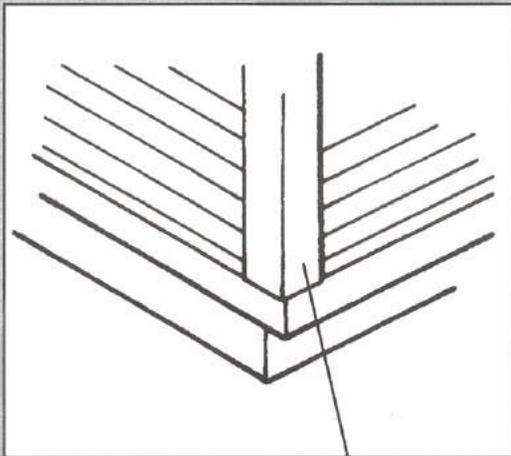

cornerboard

**conical** - shaped like a cone, usually referring to a roof

**corner board** - a narrow, vertical board installed at the corner of a wood frame structure, against which the horizontal siding abuts

**cornice** - projecting moldings forming the top band of an entablature, or a similar horizontal ornamental molding at the top of a prominent architectural element, such as a wall, window, or door

**crazing** - a condition of fine, jagged interconnected breaks or cracks in the top layer of paint, caused when thick paint becomes excessively hard and can't respond to changing weather conditions

**cresting** - a decorative series of perforated, arrow-like elements at the top of a structure, especially along the ridge of a roof

**cross gable** - a type of roof composed of two gables that intersect at right angles

**crown** - a decorative molding at the top of a window, door, or other element

**cupola** - a small structure projecting from a roof, originally intended to provide light, ventilation, or view, but may be strictly decorative

**cyclical maintenance** - the regular upkeep of all elements of a building or property

**delamination** - the separation of layers of a material

**demolition** - the intentional destruction of all or part of a building or structure

**demolition by neglect** - the destruction of a building or structure caused by the failure to perform maintenance over a period of time

**dentil** - one of a series of small, toothlike projections that alternate with blank spaces, used for decorative effect in cornices and other moldings

**deterioration** - the loss of the original sound condition of a material, structure, etc., typically due to weathering, the lack of maintenance, and/or human activity

**dormer** - a window that projects from a sloping roof



**downspout** - a vertical pipe-like element that conducts water away from a roof, typically connected to a gutter

**dusting** - the condition that occurs in masonry when the outer layer of the masonry has fallen off, and the softer, inner core is being rubbed away

**eaves** - the underside of the portion of a roof that extends beyond the face of the wall

**efflorescence** - a spotty white haze appearing in a horizontal pattern in brick, created by salts that are deposited after water that has been carried into the wall evaporates

**elevation** - one of the walls of a building

**energy efficient** - describing a building or an element of a building that provides resistance to the flow of heat, or that requires little energy to operate

**entablature** - the long horizontal structure above the capital of a column, consisting of a cornice, a frieze, and an architrave; or a similar grouping used in other locations, as above a door or window

**facade** - the front wall of a building, or any decorated wall of a building

**facing** - a non-structural material that is applied to a surface of a building for protection or ornament

**fanlight** - an arched window above a door or other window

**feature** - a single, distinguished part of a greater whole, as a single architectural element of a building

**finial** - a slender, vertical ornamental element usually positioned at the top of a roof or a gable

**finish** - the texture, color, smoothness, reflectivity, and other visual properties of a surface

**fish scale shingles** - shingles with rounded ends

**flashing** - sheet metal placed over the joints in a roof to prevent water leakage

**form** - the shape of a building or object, which contributes to character and appearance

**foundation** - the masonry base of a building that rests directly on the earth and supports the structure above

## GLOSSARY

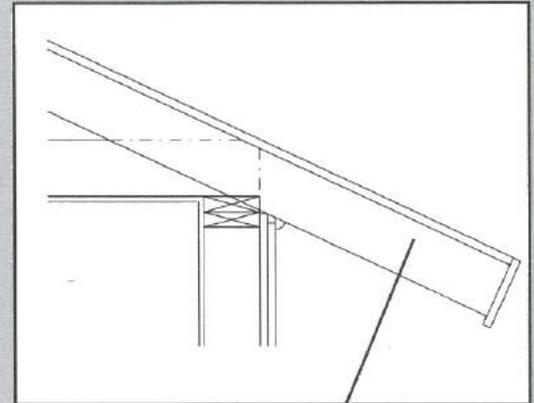

eaves

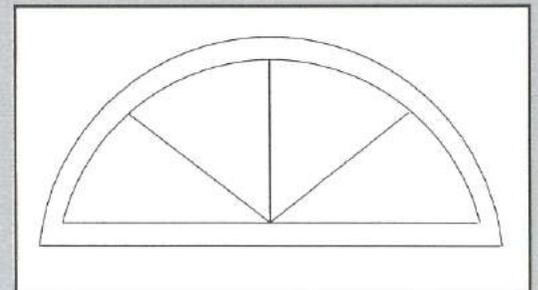

fanlight

# GLOSSARY



A gutter and downspout in Gettysburg.

- frame** - the woodwork surrounding a door or window in a wall, to which the door or window is attached
- frieze** - the flat, middle portion of the entablature, or any similar decorative, horizontal element on a building
- front gable** - a building with a gable roof and a main entrance in the gable end
- gable** - the triangular portion of the end of a building with a double-sloping roof, including the portion from the level of the eaves to the ridge
- gable end** - in a building with a gable roof, an end of the building that includes the triangular gable
- gable roof** - a simple pitched roof with sides inclined at the same angle, meeting at a peak in the center of the structure
- galvanized** - describing a material that is protected from rust with a coating of zinc
- gambrel** - a roof composed of a shallow pitched slope above a more steeply pitched slope
- glazing pattern** - the arrangement of panes in a window or door
- grade** - the height of the surface of the ground
- gutter** - a channel attached to the eaves of a building to carry rainwater away from the roof, typically attached to a downspout
- head** - the top horizontal member of a window or door frame
- hipped roof** - a roof that slopes inward from all exterior walls
- historic preservation** - a broad range of activities intended to stabilize and conserve the built environment
- historic rehabilitation** - the process of returning a historic building and/or property to a state of utility, through repair or alteration, which makes possible an efficient contemporary use while preserving those portions and features of the building and/or property that are significant to its historic, architectural, and cultural values
- ice dam** - a buildup of snow and ice at the eaves of a sloping roof

**insulation** - a material used to reduce the transmission of sound or heat

**lattice/latticework** - open screening formed by the overlapping of thin strips of wood

**lintel** - a horizontal structural element spanning a window or door opening

**louver** - a series of angled slats in a framework, incorporating spaces to admit air, often used to fill window openings

**maintenance** - the routine upkeep of a building or property, generally performed to combat the effects of weathering and age

**mansard** - a roof composed of two pitches, the lower pitch steeper than the upper pitch, which may be nearly flat

**masonry** - any of a variety of materials, including brick, stone, mortar, terra cotta, stucco, and concrete, used for building construction

**massing** - the overall composition, including the size, expanse, shape, and bulk, of the major volumes of a building, that contribute to the building's appearance, especially when the building has major and minor elements

**molding** - a long decorative trim of any of a variety of profiles, used to ornament buildings and building elements

**mortar** - a composition of sand, water, lime and/or Portland cement, and possibly other materials, used to bond masonry units together

**mullion** - the vertical member that separates windows or doors set in a series in a single opening

**multipane** - describing a window whose sash are composed of more than one pane of glass

**muntin** - the small element that separates the individual panes of glass in a multipane sash

**newel** - the post, often ornamental, that supports the handrail at the top and bottom of a stairway

**ordinance** - a municipally adopted law or regulation outlining specific rules regarding a variety of issues, but often pertaining to the use of land, property, buildings, etc.

**oriel** - a bay window above the first floor level

## GLOSSARY

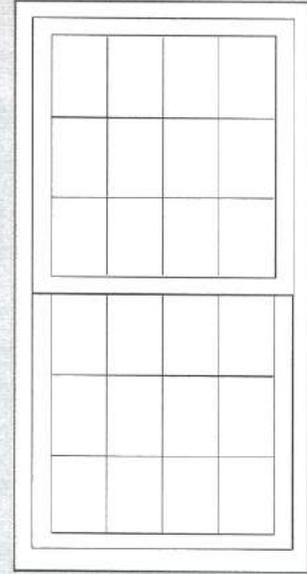

A multipane window.

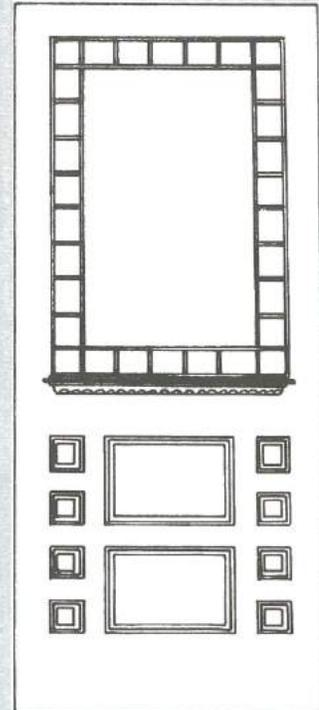

A door with a multipane window.

# GLOSSARY

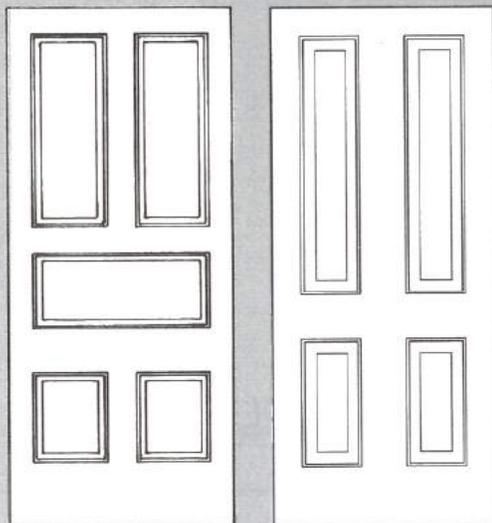
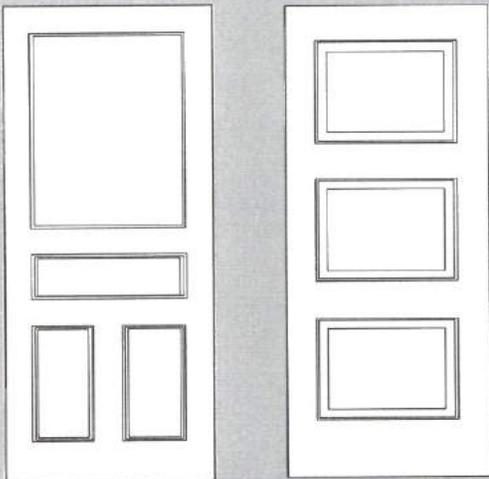

A variety of doors with panels.

**orientation** - the placement of elements on a building or the placement of a building on a site, taking into consideration size, distance, setback, alignment of features, the location of the street, and the situation of other nearby buildings

**outbuilding** - a structure separate from and secondary to the main building on a property, including but not limited to garages, carriage houses, summer kitchens, ice houses, sheds, and barns

**panel** - a flat surface surrounded by moldings or recessed from the adjacent surface and sometimes ornamented

**parapet** - a wall that projects above a roof

**pediment** - the gable end of a roof or portico, often triangular or segmental in shape, and located above the cornice in classical architecture; a similar feature above doors and windows

**physical evidence** - remaining historic fabric and/or features of a building that should be used as the basis for designing or recreating new building elements

**photographic evidence** - historic photographs or illustrations that provide information on the historic appearance of a building and that can be used as the basis for designing or recreating new building elements appropriate to the historic character of the building

**picturesque** - describing architecture that is characterized by irregularity, variety, and roughness

**pilaster** - a flat architectural element resembling a column attached to a wall

**pitch** - the slope of a roof or other element

**pointing** - the process of using mortar to bond masonry units together to form a wall

**porch** - an exterior structure attached to a building, with its own roof and a floor, and open on all sides, may be large or small, plain or decorative

**portico** - a covered porch or walkway supported by columns, typically located at the entrance to a building

**poultice** - any of a variety of compositions applied to masonry surfaces to assist in the removal of stains

**preservation** - the stabilization of a building or a material to protect it from deterioration

**primary elevation/primary facade** - an exterior wall of a building that receives special architectural treatment or ornament, often the wall that contains the entrance or any wall facing a major street

**primer** - a specially formulated coating that creates a protective film on a surface to allow good adhesion of the topcoat

**priming** - preparing a surface, or applying a first coat of paint before the finish coat(s)

**proportion** - the relationship of the size, shape, and location of one part of a building to another part, or of one part of a building to the whole building, or of one building to a group of buildings

**protect** - to safeguard the condition and character of a building or a property and its component parts, typically achieved through consistent maintenance

**protective surface coating** - a layer of material applied to a surface specifically for the purpose of shielding the surface from the elements or other potential factors of deterioration

**public street, alley, or way** - any thoroughfare for travel that is open to the public, either by foot or by vehicle, typically considered in relation to the buildings or parts of buildings that can be seen from it

**rafter** - one of a series of roof beams that supports the roof sheathing

**rail** - a horizontal framing member of a door or window

**railing** - a barrier and/or hand support typically consisting of vertical members supporting a horizontal member

**reconstruction** - the process of duplicating the original materials, form, and appearance of a vanished building or structure that was present at a particular historical moment based on historical research

**rehabilitation** - the process of returning a building to a state of utility, through repair or alteration

**reinforce** - to strengthen an architectural element by adding material and/or supporting elements in an attempt to save as much historic material as possible, as opposed to replacement

## GLOSSARY

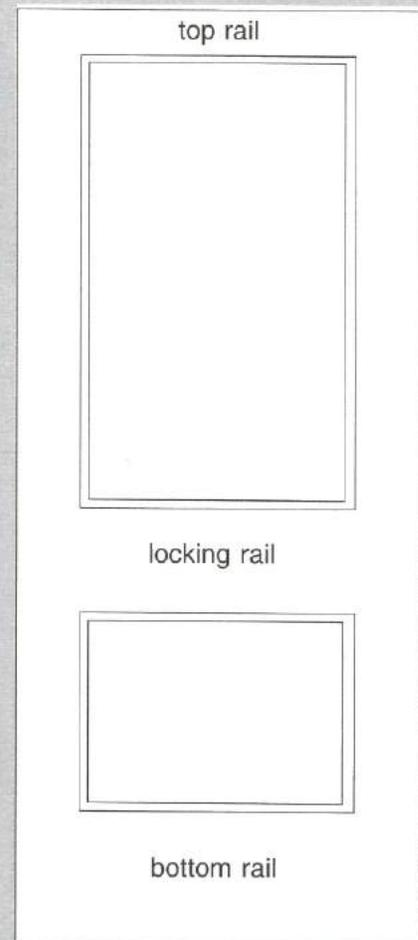

# GLOSSARY



The series of windows in this building creates a consistent rhythm.



This series of porches creates a strong rhythm along the street.

**renovation** - the process of repairing and changing an existing building for modern use, so that it is functionally equal to a new building

**repair** - to fix a deteriorated building element or material to make it functional

**replace** - to remove a building element, material, or feature and install a different element in its place, thereby removing historic fabric from a building

**repoint** - the process of removing deteriorated mortar and applying new mortar to restore the strength and appearance of a masonry wall

**resin** - a solid or semisolid organic material that provides paint with its film-forming character

**restoration** - the process of returning a building and/or property as nearly as possible to its condition at a specific period of time in its history using the same construction materials and methods as the original

**retain** - to keep a historic building element in place and/or in use, as opposed to removing the element and replacing it with a new element

**reversible** - describing an alteration or restoration technique that can be removed or otherwise undone in the future, without damaging the original historic fabric of the resource

**rhythm** - an ordered repetition of elements composing the exterior walls of a building and giving the building its character; or the repetition of buildings or building elements on a street

**ridge** - the upper edge of two sloping roof surfaces

**rising damp** - the condition that exists when suction pulls groundwater into a masonry wall from the bottom up

**roof material pattern** - primarily the shape and configuration, but also the color, texture, and other visual properties of shingles, tiles, or other material used to cover a roof

**roof shape** - the overall form of the structure that covers a building, typically identified by the placement, number, form, size, and angle of the component slopes of that structure, and by the method by which the slopes are joined

# GLOSSARY

**sandblast** - the use of sand, propelled by a blast of air or steam, to remove dirt, paint, or other materials from a wall surface, typically harmful to historic materials due to the loss of parts of the historic material along with the dirt or paint

**sash** - the unit that holds the window glass

**scale** - the perceived size of a building or building element relative to the forms and elements around it

**setback** - the distance required between a building and the property line

**sheathing** - the covering placed over the rafters as a base for the shingles or other finishing material

**shed roof** - a roof with a single slope

**shingle** - a type of roof covering consisting of small units produced in standard sizes and a variety of materials and shapes to convey a variety of appearances, laid in overlapping courses to prevent water infiltration

**shutter** - one of a pair of small, hinged doors that covers a window or other opening, may be louvered (fitted with a series of slats) or solid (fitted with raised or recessed panels)

**side gable** - a gable roof building with the main entrance on a wall that is below one of the sloping sides of the roof, not below the gable

**sidelight** - a slender, vertical window adjacent to a door or larger window, often divided into multiple panes and typically used in pairs, separated by the door or larger window

**siding** - the nonstructural exterior wall covering of a frame building

**significant** - describing a building feature that contributes to the overall design, appearance, and importance of a building, and is essential to maintaining the historic integrity of the building and/or the historic district

**significant detail/element/feature** - a detail, element, or feature that is essential to an understanding of the value and character of a historic structure or property

**significance of later changes** - over time, some changes to historic buildings may achieve significance in their own right, displaying features or characteristics of styles or types that are later than that of the original building, but which have recognized value of their own

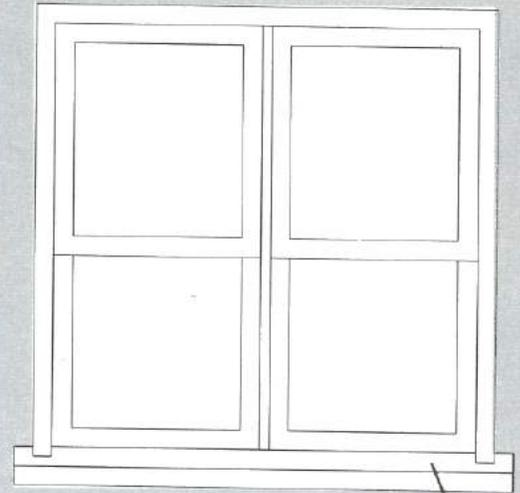

This pair of windows shares a sill.

# GLOSSARY

**turned** - describing an element that has a circular cross section produced by turning on a lathe

**valance** - the decorative horizontal element below the lintel of the porch roof

**valley** - the angle formed where two downward sloping roof surfaces meet at the bottom

**ventilation** - the process of supplying fresh air to interior spaces

**vernacular** - representing popular local building practices

**water blast** - the use of propelled water to remove dirt, paint, or other materials from a wall surface, typically harmful to historic materials if applied at too strong of a pressure due to the loss of parts of the historic material along with the dirt or paint

**weather stripping** - a long piece of material applied to an exterior door or window to seal the joint between it and the surrounding frame, used to decrease air and water infiltration

**weep hole** - an opening that allows moisture to drain to the outside of a building, typically used in storm windows

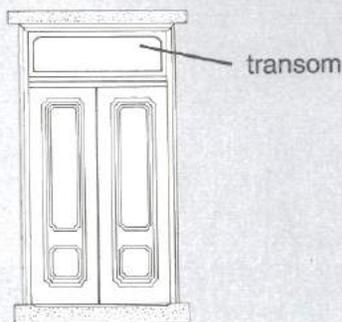

**sill** - the horizontal element at the base of a door or window opening, or at the bottom of a timber-framed wall

**slope** - an inclined surface

**solid to void ratio** - the relationship in size between the solid parts of a wall, and the openings in the wall, including door and window openings

**spalling** - the flaking of brickwork or stone due to the freezing and thawing of a wall, chemical action, or building movement

**spindle** - a wooden element that has been turned on a lathe, typically used in railings and decorative elements

**spindle work** - a series of spindles

**storefront** - the street level front of a store, including windows to display merchandise, an entrance or entrances, signs, etc.

**streetscape** - the overall view of a street and its component elements, including the street, sidewalk, buildings, signs, traffic lights, street furniture, landscaping, etc., and also including less tangible factors such as rhythm, solid-to-void ratio, changes or consistency in building height, changes or consistency in setback, etc.

**stringcourse** - a decorative, projecting horizontal molding, typically used to separate parts of a wall surface

**substrate** - a material on top of which other material is installed

**swag** - ornament composed of draped foliage

**synthetic** - referring to a manufactured material introduced in modern times, not available historically, and used as a replacement for a historic material, also called artificial

**terne** - a corrosion resistant combination of lead and tin

**texture** - the visual and tactile qualities of the structure of a surface

**tooling pattern** - the shape and profile of a mortar joint

**topcoat** - a coating whose formula is weaker than primer, but which contains more pigment

**transom** - a window located above a door, a storefront window, or another window, sometimes operable

**truss work** - an ornamental treatment, typically used in gables, resembling the structure of wooden trusses